



**umoyda**  
unlimited

**Industrial Kitchen  
Equipment Catalogue**





**umoya**  
unlimited

# Contents:

## *Category*

Cooking Equipment	3
Heating & Warming Equipment	23
Processing Equipment	33
Refridgeration Equipment	43
Dishwashers & Accessories	53
Sinks & Wash Basins	58
Tables, Shelving & Racking	61

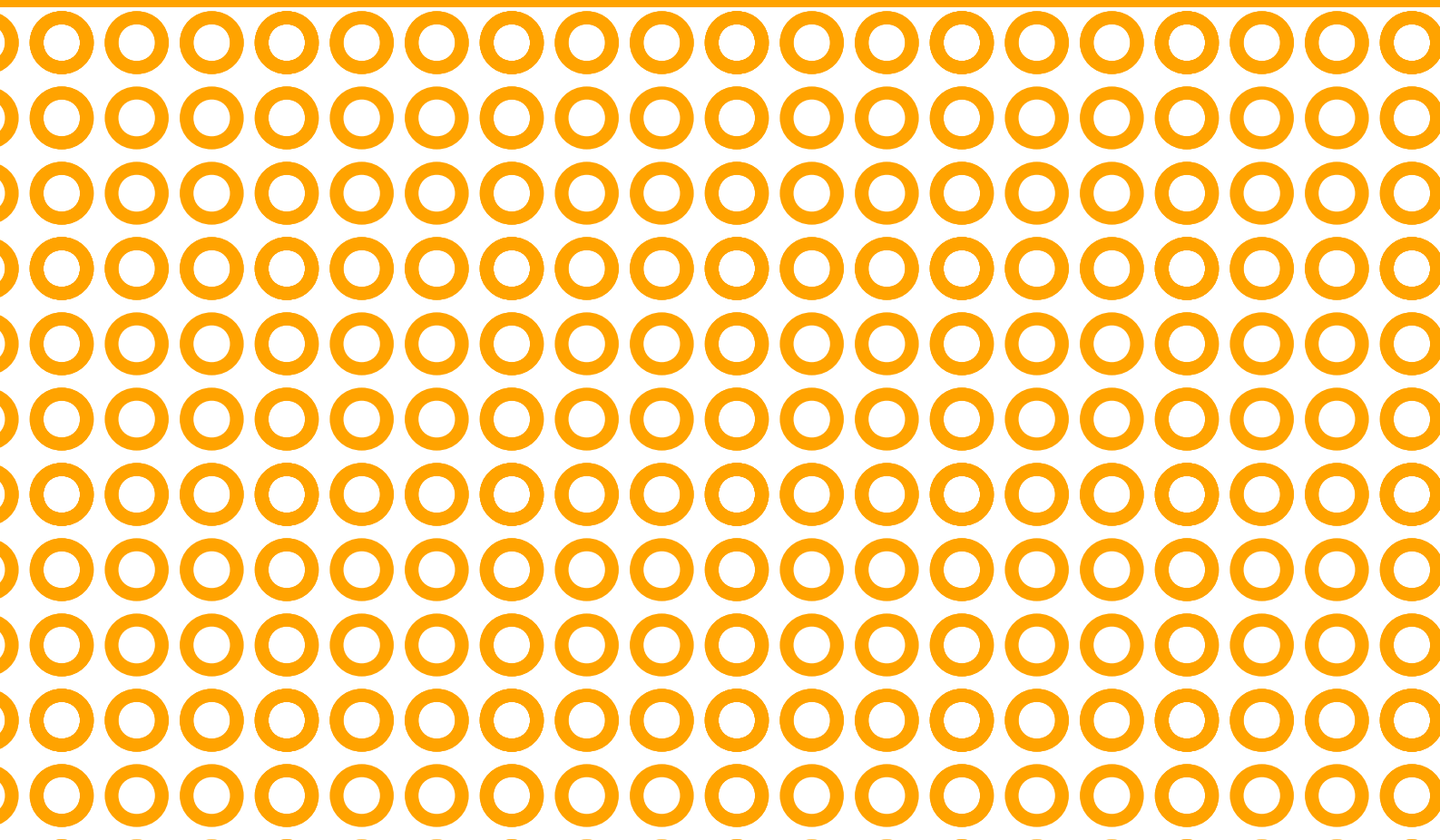

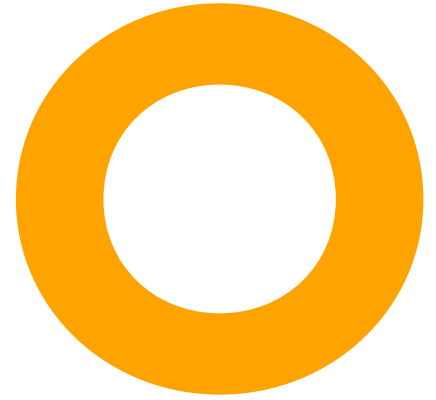

# Cooking Equipment

# Industrial Kitchen Equipment Catalogue

Order Code	Description	Capacity	Dimensions (mm)	Power	Voltage	Weight (KG)
------------	-------------	----------	-----------------	-------	---------	-------------

## Boiling Pots

### Oil Jacket



#### Electric - 135lt

CATBP135	Oil Jacketed Boiling Pot - ELECTRIC	135Lt	D1100 x H1100	18kW	380V	90kG
----------	-------------------------------------	-------	---------------	------	------	------

#### Gas - 135lt

CATBPG135	Oil Jacketed Boiling Pot - GAS - Low Amp control circuit required. Heated by tubular burners and overriding thermostat; Flame failure protection	135Lt	D1100 x H1101		220V	90kG
-----------	--	-------	---------------	--	------	------



#### Electric

CATBP5	Oil Jacketed Boiling Pot - ELECTRIC	225Lt	D1100 x H1200	18kW	380V	180kG
--------	-------------------------------------	-------	---------------	------	------	-------

CATBPG135	Oil Jacketed Boiling Pot - GAS - Low Amp control circuit required. Heated by tubular burners and overriding thermostat; Flame failure protection	225Lt	D1100 x H1201	LPG Gas; 18000 BTU	N/A	180kG
-----------	--	-------	---------------	--------------------	-----	-------

#### Oil for Pots

CATOIL	Oil for Pots; 20Lt	20Lt				
--------	--------------------	------	--	--	--	--

## Boiling Tables

### Free Standing - Straight



#### Gas - Floor Standing - 2 Burner

BCEBTG0002	Boiling Table - Gas - 2 x Burner - Straight - ON STAND	2 Burner	850 x 618 x 655mm	LPG Gas	36 000 BTU	50kG
------------	--	----------	-------------------	---------	------------	------

#### Gas - Floor Standing - 3 Burner

BCEBTG0003	Boiling Table - Gas - 3 x Burner - Straight - ON STAND	3 Burner	1280 x 618 x 655mm	LPG Gas	54 000 BTU	54kG
------------	--	----------	--------------------	---------	------------	------



#### Gas - Floor Standing - 4 Burner

BCEBTG0004	Boiling Table - Gas - 4 x Burner - Straight - ON STAND	4 Burner	1710 x 618 x 655mm	LPG Gas	72 000 BTU	76kG
------------	--	----------	--------------------	---------	------------	------

# Industrial Kitchen Equipment Catalogue

Order Code	Description	Capacity	Dimensions (mm)	Power	Voltage	Weight (KG)
<b>Boiling Tables</b>						

## Free Standing - Staggered



### Gas - Floor Standing - 4 Burner

BCEBTG1004	Boiling Table - Gas - 4 x Burner - Staggered - ON STAND	4 Burner	860 x 830 x 830mm	LPG Gas	72 000 BTU	55kG
------------	---	----------	-------------------	---------	------------	------

### Gas - Floor Standing - 6 Burner

BCEBTG1006	Boiling Table - Gas - 6 x Burner - Staggered - ON STAND	6 Burner	1280 x 618 x 655mm	LPG Gas	108 000 BTU	58kG
------------	---	----------	--------------------	---------	-------------	------

## Boiling Tables / H/Duty

### Table Top or On Stand

#### Gas - Table Top Range; Heavy Duty - 2 Burner

BCESTG0002	Boiling Table - Gas - 2 x Burner - Table Top or on Stand (see below)	2 Burner	300 x 665 x 364	52 000 BTU	GAS	52kg
BCEGGS0400	Stand for above 400mm					

#### Gas - Table Top Range; Heavy Duty - 4 Burner

BCESTG0004	Boiling Table - Gas - 4 x Burner - Table Top or on Stand (see below)	4 Burner	600 X 665 X 364	104 000 BTU	GAS	58kg
BCEGGS0600	Stand for above 600mm					

#### Gas - Table Top Range; Heavy Duty - 6 Burner

BCESTG0006	Boiling Table - Gas - 6 x Burner - Table Top or on Stand (see below)	6 Burner	900 X 665 X 364	156 000 BTU	GAS	69kg
BCEGGS0900	Stand for above 900mm					

## Gas - Stock Pot

COASP496	Boiling Table - Gas - Stock Pot	1 Burner	500 x 500 x 650	43000 BTU	GAS	
----------	---------------------------------	----------	-----------------	-----------	-----	--

## Chicken Rotisseries

BCECGA0008	Chicken rotisserie; 16 1kg Chickens	8	743 x 510 x 567	3kW	220V	38kg
BCECGA0016	Chicken rotisserie; 16 - 20 1 kg Chickens	16	943 x 560 x 617	5KW	220	58kg

BCECGA0028	Chicken rotisserie; 16 - 20 1 kg Chickens	16	943 x 560 x 617	5KW	220	58kg
------------	---	----	-----------------	-----	-----	------



# Industrial Kitchen Equipment Catalogue

Order Code	Description	Capacity	Dimensions (mm)	Power	Voltage	Weight (KG)
<b>Cooking Ranges</b>						

## Gas Only - Range and Oven



### Gas Cooking Range & Oven - 4 Burner (Both Gas)

BCECOA3004	Cooking Range; <b>With Oven</b> ; 4 Burner; <b>GAS</b>	4 Burner	700 x 750 x 900		LPG 119700 BTU	171kG
------------	--	----------	-----------------	--	----------------------	-------



### Gas Cooking Range & Oven - 6 Burner (Both Gas)

BCECOA3006	Cooking Range; <b>With Oven</b> ; 6 Burner; <b>GAS</b>	6 Burner	1050 x 750 x 900		LPG 171700 BTU	230kG
------------	--	----------	------------------	--	----------------------	-------



### Gas Cooking Range & Oven - 4 Burner & Flat Top (Both Gas)

BCECOA6004	Cooking Range; 4 Burner w Flat Top	4 Burner	1050 x 750 x 900		LPG 171700 BTU	230kG
------------	------------------------------------	----------	------------------	--	----------------------	-------

## Electric Only - Range and Oven



### Electric 4 Plate Range - WITH - Oven

CATR4E700	Electric 4 Plate Range with Electric Oven	4 Plate	700w x 750d x 850h	13.6kW	380V	65kG
-----------	---	---------	--------------------	--------	------	------



### Electric Stove - NO - Oven

CATRS3-NS	3 Plate Electric Stove - NO - Oven	3 Plate	1000L x 870w x 900h	18kW	380V	320kG
-----------	------------------------------------	---------	---------------------	------	------	-------



### Electric Stove - WITH - Oven

CATRS3	3 Plate Electric Stove - WITH - Oven	3 Plate	1000L x 870w x 900h	21KW	3 Phase & Neutral	320kG
--------	--------------------------------------	---------	---------------------	------	-------------------	-------

# Industrial Kitchen Equipment Catalogue



Order Code	Description	Capacity	Dimensions (mm)	Power	Voltage	Weight (KG)
------------	-------------	----------	-----------------	-------	---------	-------------

## Gas Hob & Electric Oven

Two Size Series; 700 & 900

### Gas Cooking Range & Electric Oven - 4 Burner

CATR4GE700	Cooking Range; Gas 4 Burner; Electric Oven - 700 Series	4 Burner	W700 x D750 x H850	13.6kW	LPG GAS	90kG
CATZH-TQ-4	Cooking Range; Gas 4 Burner; Electric Oven - 900 Series	4 Burner			LPG GAS	



### Gas Hob and Electric Oven - 4 Burner

BCECOA4004	Cooking Range Gas Burner Top; Electric Oven	4 Burner	697 x 785 x 900	4.5kW; 3 Phase	104000 BTU	184kG
------------	---	----------	-----------------	----------------	------------	-------



### Gas Hob and Electric Oven - 6 Burner

BCECOA4006	Cooking Range Gas Burner Top; Electric Oven; 6 Burner	6 Burner	1046 x 785 x 900	4.5kW; 3 Phase	156000 BTU	238kG
------------	---	----------	------------------	----------------	------------	-------



### Gas Hob and Electric Oven - 4 Burner & Flat Top

BCECOA5004	Cooking Range Gas Burner Top; Electric Oven; 4 Burner & Flat Top	4 Burner	1046 x 785 x 900	4.5kW; 3 Phase	104000 + 15400 BTU	260kG
------------	--	----------	------------------	----------------	--------------------	-------



## Fryers & Accessories

### Table Top - Electric

#### Table Top - Electric - Single - Value Range

CATEF6L	6LT Table top electric fryer	6Lt	W265 x D430 x H295	2.5Kw	220V; 14 Amps	7Kg
CATEF8L	8LT Table top electric fryer	8Lt	W265 x D430 x H345	3.25Kw	220V; 14 Amps	8Kg



#### Table Top - Electric - Double - Value Range

CATEF6L-2	2 x 6LT Table top electric fryer	2 x 6Lt	W550 x D430 x H295	2 x 2.5Kw	220V; 14 Amps	11Kg
CATEF8L-2	2 x 8LT Table top electric fryer	2 x 8Lt	W550 x D430 x H345	2 x 3.25Kw	220V; 21 Amps	14Kg



#### Table Top - Electric - Single - 5lt

BCEFFA2001	ANVIL DEEP FAT FRYER - SINGLE PAN (ELEC)	5IT	280 X 470 X 278	2.5Kw	220V	7Kg
------------	--	-----	-----------------	-------	------	-----



# Industrial Kitchen Equipment Catalogue

Order Code	Description	Capacity	Dimensions (mm)	Power	Voltage	Weight (KG)
<b>Fryers &amp; Accessories</b>						

## Table Top - Electric



### Table Top - Electric - Double - 5lt

BCEFFA2002	ANVIL DEEP FAT FRYER - DOUBLE PAN (ELEC)	2 x 5Lt	573 X 470 X 278	2 X 2.5Kw	220V	12kg
BCEFFB2250	Chip Fryer Spare Basket 8lt					



### Table Top - Electric - Single - 10lt

COAFC184	10L Single Pan; High Speed	10Lt	400 x 510 x 310	6KW	3 Phase	
----------	----------------------------	------	-----------------	-----	---------	--



### Table Top - Electric - Double - 10lt

COAFC186	10L Double Pan; High Speed	2 x 10lt	800 x 510 x 310	12KW	3 Phase	
----------	----------------------------	----------	-----------------	------	---------	--



## Table Top - Gas

### Table Top - Gas - 5.5 Lt - Value Range

CATEF711	5.5lt table top gas fryer (with safety devices)	5.5Lt	W905 x D520 x H445	18 000 BTU		10Kg
----------	---	-------	--------------------	------------	--	------



### Table Top - Gas - Double - 5.5Lt x 2 - Value Range

CATEF722	2 x 5.5lt table top gas fryer (with safety devices)	2 x 5.5Lt	W580 x D520 x H445	36 000 BTU		16Kg
----------	---	-----------	--------------------	------------	--	------



### Table Top - Gas - Single - 8lt

BCEFFA4010	Fryer Single; Gas; 8Lt	8Lt	W300 x D576 x H429	Gas; 11000 BTU	N/A	11kG
------------	------------------------	-----	--------------------	----------------	-----	------



### Table Top - Gas - Double - 8lt

BCEFFA4020	Fryer Double; Gas; 8Lt	8Lt x 2	W612 x D576 x H429	Gas; 22000 BTU	N/A	21kG
------------	------------------------	---------	--------------------	----------------	-----	------



# Industrial Kitchen Equipment Catalogue

Order Code	Description	Capacity	Dimensions (mm)	Power	Voltage	Weight (KG)
<b>Freestanding - Electric</b>						



<b>Fryers - Free Standing - Electric - Single Tank - 2 x Baskets</b>						
BCEFFA6120	Chip Fryer Floor Standing; Sgl Well; 2 x Baskets sold separately	20Lt	600 x 510 x 1025mm	12kW	380V; 3 Ph	45kG



<b>Fryers - Free Standing - Electric - 10Lt Double Tanks - 2 x Baskets (Separate Controls)</b>						
BCEFFA6210	Chip Fryer Floor Standing; Double Well; 2 x 10Lt Baskets sold separately	2 x 10Lt	600 x 510 x 1025mm	2 x 6kW	380V; 3 Ph	45kG



<b>Fryers - Free Standing - Electric - 20Lt Double Tanks - 4 x Baskets (Separate Controls)</b>						
BCEFFA6220	Chip Fryer Floor Standing; Double Well; 4 x Baskets sold separately	2 x 20Lt	1012 x 660 x 1000mm	2 x 12kW	380V; 3 Ph	90kG

## Freestanding - Gas



<b>Fryer - Free Standing - Gas - Single Tank - 2 x Baskets</b>						
BCEFFA3200	Chip Fryer Floor Standing; 2 x 10Lt; No Baskets	2 x 10Lt	400 x 870 x 1080mm	90 000 BTU		70kG

## Fryer Accessories- Generic



<b>Skimmer - Spider - 180mm</b>						
BCESKS1180	Skimmer - Spider 180mm	180mm				



<b>Skimmer - Round - 180mm</b>						
BCESKR0178	Skimmer - Round 178mm	178mm				



<b>Chip Scoop</b>						
BCECBS0001	Chip Bagging Scoop;		190 x 200			

# Industrial Kitchen Equipment Catalogue

Order Code	Description	Capacity	Dimensions (mm)	Power	Voltage	Weight (KG)
<b>Chip Baskets</b>						
BCECBS0280	Chip Basket; Square; side hooks		280 x 170 x 130			
BCECBS2280	Chip Basket; Square; no side hooks		280 x 170 x 130			
BCEFFB3200	Chip Basket; Square; no side hooks		280 x 170 x 130			



## Griddles

### Flat Top - Table Top - Electric - 355mm

BCEFTA0400	Flat Top Griddle; 355 x 420mm		373 x 532 x 241	3KW	230	20kg
------------	-------------------------------	--	-----------------	-----	-----	------



### Flat Top - Table Top - Electric - w Egg Section - 355mm

BCEFTA4400	Flat Top Egg Griddle; 355 x 420mm		373 x 532 x 241	3KW	230	20kg
------------	-----------------------------------	--	-----------------	-----	-----	------



### Flat Top - Table Top - Electric - 605mm

BCEFTA0600	Flat Top Griddle; 605 x 420mm		623 x 532 x 241	3KW	230	32kg
------------	-------------------------------	--	-----------------	-----	-----	------



### Flat Top - Table Top - Electric - w Egg Section - 605mm

BCEFTA1600	Flat Egg & Bacon Griddle; 605 x 420mm		623 x 532 x 241	2KW	230	32kg
------------	---------------------------------------	--	-----------------	-----	-----	------



### Flat Top - Table Top - Electric - w Egg Section - 355mm

BCEFTA2600	Flat Top Griddle; Half Flat & Half Ribbed 605 x 420mm		623 x 532 x 241	3KW	230	32kg
------------	---	--	-----------------	-----	-----	------



### Flat Top - Table Top - Gas - 398mm

BCEFTA2400	Flat top griddle; Flat surface; Gas ; 398 x 395		425 x 446 x 244	10000 BTU	GAS	18kg
------------	---	--	-----------------	-----------	-----	------



### Flat Top - Table Top - Gas - 398mm

BCEFTA0750	Flat top griddle; Flat; Gas ; 757 x 398		787 X 446 X 244	20000 BTU	GAS	30kg
------------	---	--	-----------------	-----------	-----	------



### Flat Top - Table Top - Gas - 398mm

BCEFTA1750	Flat top griddle; Gas ; Ribbed / Flat; 757 x 398		787 X 446 X 244	20000 BTU	GAS	30kg
------------	--	--	-----------------	-----------	-----	------



# Industrial Kitchen Equipment Catalogue

Order Code	Description	Capacity	Dimensions (mm)	Power	Voltage	Weight (KG)
<b>Fry Top Gas Grillers - Table Top or With Stand</b>						



<b>Flat top griller; 400mm</b>						
BCEFTG0400	Flat Top gas Griller - 400mm		455 x 670 x 390mm	28 000 BTU	LPG	60kG
BCEGGS0400	Stand for above		400mm			



<b>Flat top griller; 600mm</b>						
BCEFTG0600	Flat Top gas Griller - 600mm		603 x 670 x 390mm	56 000 BTU	LPG	72kG
BCEGGS0600	Stand for above		600mm			



<b>Flat top griller; 900mm</b>						
BCEFTG0900	Flat Top gas Griller- 900mm		903 x 670 x 390mm	84 000 BTU	LPG	120kG
BCEGGS0900	Stand for above		900mm			

## Grillers

<b>Table Models</b>						
COAGC301	Griller - Table Top	6 Burner	990 X 560 X 310	120000 BTU	GAS	
COAGC302	Griller - Table Top	4 Burner	710 X 560 X 310	80000 BTU	GAS	
COAGC303	Griller - Table Top	2 Burner	430 X 560 X 310	40000 BTU	GAS	

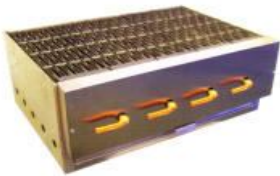

<b>Grillers - Free Standing - 4 Burner</b>						
BCEGGA3004	Gas Griller; Free Standing; 4 Burner	4 Burner	905 x 521 x 640	30 000 BTU	LPG GAS	60kG



<b>Grillers - Free Standing - 6 Burner</b>						
BCEGGA3006	Gas Griller; Free Standing; 6 Burner	6 Burner	905 x 807 x 640	45 000 BTU	GAS	81kg
BCEGGA1006	1/3 Solid Plate for 6 burner		275 X 460			



<b>Grillers - Free Standing - 10 Burner</b>						
BCEGGA3010	Gas Griller; Free Standing; 10 Burner	10 Burner	905 x 1307 x 640	75 000 BTU	GAS	138kg
BCEGGA1010	1/3 Solid Plate for 10 burner		415 X 460			



# Industrial Kitchen Equipment Catalogue

Order Code	Description	Capacity	Dimensions (mm)	Power	Voltage	Weight (KG)
------------	-------------	----------	-----------------	-------	---------	-------------

## Grillers



### Grillers - Free Standing - 4 Burner - In Cabinet

CVG5	Gas Griller; 575; Front door to suite Cast iron grids or 10mm mild steel grids S/Steel radiant reflective baffles or Lava Rock; Gas connection: 20mm BSP	4 Burners	575(W) x 800(D) x 950(H)	88 000 kJ/Hr	LPG 2.7 Kpa	
------	--	-----------	--------------------------------	-----------------	----------------	--



### Grillers - Free Standing - 6 Burner - In Cabinet

CVGR8	Gas Griller; 850 OPTIONS; Front door to suite Cast iron grids or 10mm mild steel grids St/steel radiant reflective baffles or Lava Rock; Gas connection: 20mm BSP	6 Burners	850(W) x 800(D) x 950(H)	95 000 kJ/Hr	LPG 2.7 Kpa	
-------	---	-----------	--------------------------------	-----------------	----------------	--

## Grillers



### Grillers - Free Standing - 10 Burner - In Cabinet

CVG12	Gas Griller; 1275; OPTIONS; Front door to suite Cast iron grids or 10mm mild steel grids St/steel radiant reflective baffles or Lava Rock; Gas connection: 20mm BSP	10 Burners	1275(W) x 800(D) x 950(H)	177 000 kJ/Hr	LPG 2.7 Kpa	
-------	---	---------------	---------------------------------	------------------	----------------	--



### Grillers - Free Standing Combi - 6 Burner & Flat Top - In Cabinet

CVG8C	Gas Griller; Combi 850 OPTIONS; Front door to suite Cast iron grids or 10mm mild steel grids St/steel radiant reflective baffles or Lava Rock; Gas connection: 20mm BSP	6 Burners	850(W) x 800(D) x 950(H)	95 000 kJ/Hr	LPG 2.7 Kpa	
-------	---	-----------	--------------------------------	-----------------	----------------	--

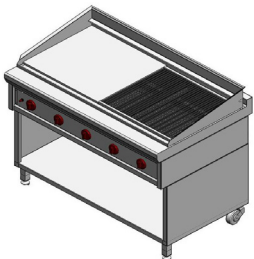

### Grillers - Free Standing - 10 Burner - In Cabinet

CVG12C	Gas Griller; Combi 1275; OPTIONS; Front door to suite Cast iron grids or 10mm mild steel grids St/steel radiant reflective baffles or Lava Rock; Gas connection: 20mm BSP	10 Burners	1275(W) x 800(D) x 950(H)	177 000 kJ/Hr	LPG 2.7 Kpa	
--------	---	---------------	---------------------------------	------------------	----------------	--

## Hot Plates



### Hot Plate - Single

BCESTA0001	Stove Single plate; 255mm		333 x 508 x 222	2kW	230V	7kg
------------	---------------------------	--	--------------------	-----	------	-----



### Hot Plate - Double

BCESTA0002	Stove Double plate; 1 x 190; 1 x 225mm		580 x 508 x 222	1 x 1.2kW; 1 x 2kW	230V	11kg
------------	--	--	--------------------	--------------------------	------	------

# Industrial Kitchen Equipment Catalogue

Order Code	Description	Capacity	Dimensions (mm)	Power	Voltage	Weight (KG)
<b>Induction Cookers</b>						



<b>Induction Cooker Control on Plate</b>						
BCEIND0002	Induction Cooker ; Control on Plate	3400w	310 x 310 x 60	3400W	220-240V	2.4Kg



<b>Induction Cooker - Controls in front</b>						
BCEIND1001	Induction Cooker ;	3500W	390 x 390 x 90	3500W	220-240V	5.38Kg



<b>Induction Wok</b>						
CATINDCW	Induction Wok		W350xD450x H135	3kW	220-240V	7.6kG

## Industrial Microwaves



<b>Microwave - 25lt</b>						
BCEMWS1000	Industrial Microwave; Stainless Steel; Sharp; 28Lt	28Lt	W530xD406x H309	1000W		23kG



<b>Microwave - 34lt</b>						
BCEMWM1100	Industrial Microwave; S/Steel	34Lt	550 x 514 x 362	1000W	240V	19kG

## Ovens & Accessories



<b>Convection Oven - Prima</b>						
BCECOA1003	Convection Oven - Prima; 4 x Chrome Grids 445 x 320mm		595 x 622 x 590	2.4KW	230	41kG



<b>Convection Oven - Prima w Grill &amp; Timer</b>						
BCECOA1004	Convection Oven - Prima; with Grill & Timer; 4 x Chrome Grids 445 x 320mm		596 x 622 x 590	2.4KW	230	41kG



<b>Convection Oven - Prima - Digital</b>						
BCECOA1203	Convection Oven - Prima; 4 x Chrome Grids 445 x 320mm - DIGITAL PROGRAMMABLE CONTROLLER		595 x 622 x 590	2.4KW	230	41kG

# Industrial Kitchen Equipment Catalogue

Order Code	Description	Capacity	Dimensions (mm)	Power	Voltage	Weight (KG)
------------	-------------	----------	-----------------	-------	---------	-------------

## Baking Tray - Solid

BCECOA2004	Baking Tray <b>Solid</b> - for above		445 x 320			
------------	--------------------------------------	--	-----------	--	--	--

## Baking Tray - Perforated

BCECOA0010	Baking Tray <b>Perforated</b> - for above		445 x 320			
------------	---	--	-----------	--	--	--

## Chrome Grid

BCECOA2003	Chrome Grid - for above		445 x 320			
------------	-------------------------	--	-----------	--	--	--

## Convection Oven - Grand Forni

BCECOA1005	Convection Oven Grande Forni; <b>with Steam &amp; Timer</b> ; 2 x Chrome Grids		835 x 759 x 590	5.6kW	230; 2 Phase	70kG
------------	--	--	-----------------	-------	--------------	------

## Convection Oven - Grand Forni - w Steam & Timer

BCECOA1205	Convection Oven Grande Forni; <b>with Steam &amp; Timer</b> ; 2 x Chrome Grids - DIGITAL		835 X 759 X 590	5.6kW	230; 2 Phase	70kG
------------	--	--	-----------------	-------	--------------	------

## Grand Forni Stand

BCECOR0005	Grande Forni Stand		840 x 710 x 900			
------------	--------------------	--	-----------------	--	--	--

## Baking Tray - Solid

BCEBTA0011	Baking Tray Solid - for above		600 x 400			
------------	-------------------------------	--	-----------	--	--	--

## Baking Tray - Perforated

BCECOR3003	Baking Tray Perforated - for above		600 x 400			
------------	------------------------------------	--	-----------	--	--	--

## Chrome Grid

BCECOR3001	Chrome Grid - for above		600 x 400			
------------	-------------------------	--	-----------	--	--	--

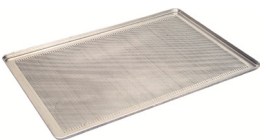

# Industrial Kitchen Equipment Catalogue

Order Code	Description	Capacity	Dimensions (mm)	Power	Voltage	Weight (KG)
------------	-------------	----------	-----------------	-------	---------	-------------



### Convection Oven - 6 Pan - Anvil

BCECOA1006	Convection Oven 6-PAN Combi Steam; with 70mm spacing	6 Pan	868 x 968 x 740	12kW	380V	144kg
------------	--	-------	-----------------	------	------	-------



### Convection Oven - 10 Pan - Anvil

BCECOA1010	Convection Oven Combi Steam; 10 Pan	10 Pan	868 x 968 x 920	18kW	380V	160kg
------------	-------------------------------------	--------	-----------------	------	------	-------



### Stand for Oven - 6 & 10 Pan - Anvil

BCECOA1011	Convection Oven Stand - for above		970 x 675 x 860			
------------	-----------------------------------	--	-----------------	--	--	--

## Ovens & Accessories



### Convection Oven - 4 Pan - Prenox

ED100000	Convection Oven 4-PAN Combi Steam; 4 Pan with 65mm spacing	4 Pan	826 x 602 x 558	2.8kW	220V	
----------	--	-------	-----------------	-------	------	--



### Stand for Oven - 4 Pan - Anvil

ED130000	Convection Oven Stand - for above		770 x 520 x 860			
----------	-----------------------------------	--	-----------------	--	--	--



### Convection Oven - 10 Pan - Electric - Prenox

ED100015	Convection Oven <b>20-PAN</b> Vertical Combi Steam (includes trolley)	20 Pan	890 x 830 x 1760	30kW	380V	
ED130005	Convection Oven Stand - for above					



### Convection Oven - 10 Pan - GAS - Prenox

ED130020	Convection Oven 10-pan <b>Gas</b> Combi Steam; 10 Pan	10 pan	960 x 805 x 1160	15000 BTU	220V	
ED130010	Convection Oven Stand - for above					

# Industrial Kitchen Equipment Catalogue



Order Code	Description	Capacity	Dimensions (mm)	Power	Voltage	Weight (KG)
------------	-------------	----------	-----------------	-------	---------	-------------



### Roll in Rack - 10 Pan Gas & Electric - Prenox

ED130025	Roll in Rack - for 10 Pans		585 x 390 x 700			
----------	----------------------------	--	-----------------	--	--	--



### Trolley Roll In - 10 Pan Gas & Electric - Prenox

ED130035	Trolley Roll In - for 10 Pans		600 x 390 x 895			
----------	-------------------------------	--	-----------------	--	--	--

### Optional Extra for 4, 6 & 10 Pan

ED110045	Cleaning Spray					
----------	----------------	--	--	--	--	--



### Chromed Grids - Prenox

ED110010	Chromed Grid; EN 1/1		530 x 375			
ED110005	Chromed Grid; EN 1/1		530 x 325			



### Aluminium Trays - Prenox

ED110020	Aluminium Tray; EN 1/1		530 x 375			
ED110015	Aluminium Tray; EN 1/1		530 x 325			



### Convection Oven - 20 Pan - Prenox

ED100030	Convection Oven <b>20-PAN</b> Vertical Combi Steam (includes trolley)	20 Pan	890 x 830 x 1760	30kW	380V	
----------	---	--------	------------------	------	------	--

### Optional Extras For 20 Pan

ED110065	Cleaning Spray					
ED110005	Chromed Grid; EN 1/1		530 x 325			
ED130015	Aluminium Tray; EN 1/1		530 x 325			



### Trolley - 20 Pan - Prenox

ED130042	Trolley; Floor Level for Convection Oven 20 Pans - Roll In					
----------	--	--	--	--	--	--



### Convection Oven - 40 Pan - Prenox

ED100035	Convection Oven <b>40-PAN</b> Vertical Combi Steam (includes trolley)	40 Pan	1150 x 953 x 1760	45kW	380V	
----------	---	--------	-------------------	------	------	--

### Optional Extras For 40 Pan

ED110070	Cleaning Spray					
ED110005	Chromed Grid; EN 1/1		530 x 325			
ED130015	Aluminium Tray; EN 1/1		530 x 325			
ED130032	Roll-In Rack for Convection Oven					



### Trolley - 40 Pan - Prenox

ED130041	Trolley Roll In for Convection Oven					
ED130043	Trolley Floor Level for Convection Oven					



# Industrial Kitchen Equipment Catalogue

Order Code	Description	Capacity	Dimensions (mm)	Power	Voltage	Weight (KG)
------------	-------------	----------	-----------------	-------	---------	-------------

## Ovens - Combi Convection - Programmable / Manual



Convection Oven - 4 Tray - Piron						
BCECOP5004	Convection Oven; 4 x Tray - <b>MANUAL - NO HUMIDITY</b> ; includes 4 x solid trays	4 Tray; 442 X 325mm	550 x 585 x 505	2.6kW	230V - 50/60HZ	29.5kG



Convection Oven - 4 Tray - Digital - Piron						
BCECOP5014	Convection Oven; 4 x Tray - <b>DIGITAL - W HUMIDITY</b> ; 10 x Cooking programs; includes 4 x solid trays	4 Tray; 442 X 325mm	550 x 585 x 505	2.6kW	230V - 50/60HZ	29.5kG



Convection Oven - 4 Tray - Piron						
BCECOP8004	Convection Oven; 4 x Tray- <b>W HUMIDITY</b> ; Includes 2 x solid trays	4 Tray; 600 x 400	800 x 755 x 516	6.2kW	230V 400V ; 50/60hz	80kG

## Ovens - Combi Convection - Programmable / Manual



Convection Oven - 4 Tray - Digital - Piron						
BCECOP5014	Convection Oven; 4 x Tray - <b>DIGITAL - W HUMIDITY</b> ; Includes 2 x solid trays; 10 x cooking programs	4 Tray; 600 x 400	800 x 755 x 516	6.2kW	230V 400V ; 50/60hz	80kG



Convection Oven Stand - Piron						
BCECOP8001	Convection Oven Stand; Stainless Steel					



Convection Oven - 6 Pan - Digital - Piron						
BCECOP9006	Combi Convection Steam Oven; 6 x GN 1/1 - <b>DIGITAL</b> ; 99 programs; includes 3 x GN 1/1 pans	6 Pan	920 x 880 x 840	8.4kW	400v; 50/60Hz	116kG



Convection Oven - 10 Pan - Digital - Piron						
BCECOP9010	Combi Convection Steam Oven; 10 x GN 1/1 - <b>DIGITAL</b> ; 99 programs; includes 4 x GN 1/1 pans	10 Pan	920 x 880 x 1190	12.4kW	400v; 50/60Hz	143kG

# Industrial Kitchen Equipment Catalogue

Order Code	Description	Capacity	Dimensions (mm)	Power	Voltage	Weight (KG)
------------	-------------	----------	-----------------	-------	---------	-------------



## Convection Oven Stand - Piron

BCECOP9001	Convection Oven Stand; Stainless Steel					8Kg
------------	--	--	--	--	--	-----



## Oven Accessories - Piron

BCECOP9002	Hand Shower kit					
------------	-----------------	--	--	--	--	--

## Inserts for Ovens

BCEINF2065	Convection Insert Solid 65mm					
BCEINF3065	Convection Insert Perforated 65mm					

## Deck Ovens



### 1 Deck - Value Range

CATSL3	1 Deck 3 Pan; 3 x 600 x 400 Pans Per Deck	3 Pan	W1655 x D770xH530	7.7kW	220v	160kg
--------	---	-------	-------------------	-------	------	-------



### 2 Deck - Value Range

CATSL6	2 Deck 3 Pan; 3 x 600 x 400 Pans Per Deck	8 Pans	W1655x D770xH1240	13.2kW	380v 3 Ph	170kg
--------	---	--------	-------------------	--------	--------------	-------



### 3 Deck - Value Range

CATSL9	3 Deck 3 Pan; 3 x 600 x 400 Pans Per Deck	12 Pan	W1660 x D910xH1565	24kW	380v 3 Ph	380kg
--------	---	--------	--------------------	------	--------------	-------



### Deck Ovens

BCEDOA0001	Deck Oven; Single; 4 std size pizzas; includes 2 x baking trays; 600 x 400	4 Pan	1220 x 875 x 570	6.6kW	380v 3 Ph	90kg
BCEDOA0002	Deck Oven; Double; 8 std size pizzas; includes 4 x baking trays; 600 x 400	8 Pans	1220 x 875 x 950	13.2kW	380v 3 Ph	170kg
BCEDOA0003	Deck Oven; Triple; 12 std size pizzas; includes 6 x baking trays; 600 x 400	12 Pan	1220 x 875 x 1450	19.8kW	380v 3 Ph	250kg
BCEDOA1001	Deck Oven; Single; 8 std size pizzas; includes 3 x baking trays; 600 x 400	8 Pans	1830 x 875 x 570	9kW	380v 3 Ph	120kg
BCEDOA1002	Deck Oven; Double; 16 std size pizzas; includes 6 x baking trays; 600 x 400	16 Pans	1830 x 875 x 950	18kW	380v 3 Ph	220kg
BCEDOA1003	Deck Oven; Triple; 24 std size pizzas; includes 9 x baking trays; 600 x 400	24 Pan	1830 x 875 x 1450	27kW	380v 3 Ph	325kg



# Industrial Kitchen Equipment Catalogue

Order Code	Description	Capacity	Dimensions (mm)	Power	Voltage	Weight (KG)
<b>Pizza Oven - Conveyor</b>						



## Conveyor Toaster - Value Range

CATHX-1	Conveyor Pizza Oven; 16 per hour		W1220 x D570xH475	6.3kW	220V	47kG
---------	----------------------------------	--	----------------------	-------	------	------

## Conveyor Toaster

BCEPOA2001	Pizza Oven Conveyor 16 per hour		W1120 x D570 x H475	6.3kW	220V	47kG
------------	---------------------------------	--	------------------------	-------	------	------

## Ovens - Proovers

### Proover - 13 Pans

CATGX13A	Proover Electric; 13 Pans	13 Pans	500 x 710 x 1740	2.7kW	220v	65kG
----------	---------------------------	---------	---------------------	-------	------	------



### Proover - 28 Pans

CATGX26A	Proover Electric; 28 Pans	28 Pans	1150 x 720 x 1670	3.4kW	220v	90kG
----------	---------------------------	---------	----------------------	-------	------	------



## Pasta Cooker

BCEPRA0001	Electric Pasta Cooker			2.5kW	220v	16kG
------------	-----------------------	--	--	-------	------	------



## Pop Corn Machine

GLWTP6E/6A	Pop Corn machine	200kg	502 x 421 x 685	1.5kW	220v	26kg
------------	------------------	-------	--------------------	-------	------	------



# Industrial Kitchen Equipment Catalogue

Order Code	Description	Capacity	Dimensions (mm)	Power	Voltage	Weight (KG)
<b>Salamanders</b>						



### Salamander - 580W - Value Range

CATSAL002	Electric Salamander; W580		w580 x d390 x h390	2.2kW	220v	11kG
-----------	---------------------------	--	-----------------------	-------	------	------



### Salamander - 800W - Value Range

CATSAL004	Electric Salamander; W800		w800 x d450 x h470	4kW	220v	28kG
-----------	---------------------------	--	-----------------------	-----	------	------



### Salamander - 728 x 506mm

BCESAA0001	Salamander 728 x 506 x 428mm; 3KW; s Phase		728 x 506 x 428	3kW	380V	20kG
------------	--	--	--------------------	-----	------	------



### Salamander - 480 x 270mm

BCESAA0005	Salamander; 480 X 270 X 375		480 X 270 X 375	3Kw	220v	12Kg
------------	-----------------------------	--	--------------------	-----	------	------



### Salamander - GAS

BCESAG0001	Salamander - <b>GAS</b>	75Lt	450 x 900 x 420mm	16 000 BTU		30Kg
------------	-------------------------	------	----------------------	---------------	--	------



## Tilting Pans

### Tilting Pan - S/Steel

ED120240	Tilting Pan; on stand; 50 Lt; <b>STAINLESS STEEL BIN</b>	50Lt	W800 x 300D x 700H	7.5kW	380V; 3 Ph; 35Amp	
----------	--	------	-----------------------	-------	-------------------------	--



### Tilting Pan - Cast Iron

COAFC352	Tilt - Fry Pans; 40LT; Cast Iron Bin	40Lt	1120 X 850 X 900	6kW	380V & N	
COAFC351	Tilt - Fry Pans; 80LT; Cast Iron Bin	80Lt	1260x 1000 x 900	12kW	380V & N	



### Tilting Skillet

CATSKIL01	Tilting Skillet; Stainless Steel; Pan size L690 x W450 x D180; Heated by 3 Incaloy sheathed elements	40Lt	W800 x D750 x H930	7.5kW	380V	220kG
-----------	--	------	-----------------------	-------	------	-------

# Industrial Kitchen Equipment Catalogue

Order Code	Description	Capacity	Dimensions (mm)	Power	Voltage	Weight (KG)
<b>Toasters</b>						



<b>Toast Maker - 4 Slice - Value Range</b>						
CATTOST4	Toast maker 4 Slice	4 Slice	370 X 210 X 225	2kW	220	6kG



<b>Toast Maker - 6 Slice - Value Range</b>						
CATTOST6	Toast maker 4 Slice	6 Slice	660 X 210 X 225	3kW	220	8kG



<b>Toasters</b>						
<b>Toast Maker - 8 Slice - Value Range</b>						
BCETSA9009	Toast maker 4 Slice	4 Slice	370 X 210 X 225	2kW	220	6Kg



<b>Toast Maker - Conveyor - Value Range</b>						
CATCVTE	Conveyor Toaster; 300 to 350 Slice P/H		430 x 370 x 390	1.94kW	220	27kG



<b>Toast Maker - 4 Slice</b>						
BCETSK0004	Toast maker 4 Slice	4 Slice	370 X 210 X 225	2.24kW	220	4kg



<b>Toast Maker - 6 Slice</b>						
BCETSK0006	Toast maker 6 Slice	6 Slice	460 x 210 x 225	3.24kW	220V	6kg



<b>Toast Maker - Conveyor</b>						
BCECTK0001	Toast maker Conveyor	Approx 300 slice per Hour	367 x 761 x 424	2.99kW	220	17.5kG



<b>Toaster - Sandwich - 9 Slice</b>						
BCETSA1009	Toaster 9 Slice Sandwich Flat		355 x 466 x 327	2.15kW	230V	14kG

# Industrial Kitchen Equipment Catalogue

Order Code	Description	Capacity	Dimensions (mm)	Power	Voltage	Weight (KG)
------------	-------------	----------	-----------------	-------	---------	-------------



Toaster - Sandwich - Ribbed - 9 Slice						
BCETSA9009	Toaster 9 Slice Sandwich Ribbed		356 x 466 x 327	2.15kW	230V	14kG

## Toasters



Panini Toaster						
BCEPGT0001	Panini Toaster; Cast Iron;		410 x 378 x 205	2.6kW	220	22kg

## Waffle Makers



Waffle Maker - Single						
BCEWBA0001	Waffle Baker 1 Plate	Plate Diameter 185mm	280 x 465 x 260	.8kW	220V	8kg



Waffle Maker - Double						
BCEWBA0002	Waffle Baker 2 Plate	2 x Plate Diameter 185mm	510 x 465 x 260	1.6kW	220v	17kg

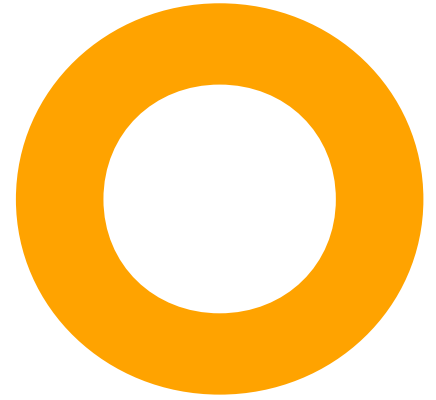

# Heating & Warming Equipment

# Industrial Kitchen Equipment Catalogue

Order Code	Description	Capacity	Dimensions (mm)	Power	Voltage	Weight (KG)
------------	-------------	----------	-----------------	-------	---------	-------------

## Bain Maries

### Bain Maries - Table Models



#### Bain Marie - Table Model - 1 Division - Value Range

CATBS2T	Bain Marie - Table Top 1 Division; Includes inserts	2 x 1/2 Inserts	590 x 354 x 240	0.8kW	220v	9kG
---------	--	-----------------	--------------------	-------	------	-----



#### Bain Marie - Table Model - 2 Division - Value Range

CATBS4T	Bain Marie - Table Top 2 Division; Includes inserts	4 x 1/2 Inserts	590 x 694 x 240	1.5kW	220v	16kG
---------	--	-----------------	--------------------	-------	------	------



#### Bain Marie - Table Model - 3 Division - Value Range

CATBS6T	Bain Marie - Table Top 3 Division; Includes inserts	6 x 1/2 Inserts	590 x 1035 x 240	1.8kW	220v	22.5kG
---------	--	-----------------	---------------------	-------	------	--------



#### Bain Marie - Table Model - 1 Division

BCEBMA0001	Bain Marie - Table Top 1 Division; Includes inserts	2 x 1/2 Inserts	400 x 770 x 268	2.7kW	230v	12kG
------------	--	-----------------	--------------------	-------	------	------



#### Bain Marie - Table Model - 2 Division

BCEBMA0002	Bain Marie - Table Top 2 Division; Includes inserts	4 x 1/2 Inserts	739 x 770 x 268	2.7kW	230v	18kG
------------	--	-----------------	--------------------	-------	------	------



#### Bain Marie - Table Model - 3 Division

BCEBMA0003	Bain Marie - Table Top 3 Division; Includes inserts	6 x 1/2 Inserts	1080 x 770 x 268	3kW	230v	22kG
------------	--	-----------------	---------------------	-----	------	------



#### Bain Marie - Table Model - 5 Division

COABC054	Bain Marie; 5 x Pan	5 x Full Inserts	1755 x 670 x 310H	3kW	220V	
----------	---------------------	---------------------	----------------------	-----	------	--



#### Bain Marie - Table Model - 1 Division - GAS

BCEBMA3001	Bain Marie - GAS - Table Top 1 Division	1 Division	400 x 750 x 268	75 000 BTU	n/a	15Kg
------------	--	------------	--------------------	---------------	-----	------



# Industrial Kitchen Equipment Catalogue

Order Code	Description	Capacity	Dimensions (mm)	Power	Voltage	Weight (KG)
------------	-------------	----------	-----------------	-------	---------	-------------

## Bain Marie - Freestanding Models

### Bain Marie - Free Standing - 3 Division (Excluding Inserts)

MARBAIN3HC	Bain Marie w Hot Closet; 3 Division	3 x 1/1 GN pans	1065(W) x 650(D) x 900(H)			
MARBAIN3CC	Bain Marie w Cold Closet; 3 Division					

### Bain Marie - Free Standing - 4 Division (Excluding Inserts)

MARBAIN4HC	Bain Marie w Hot Closet; 4 Division	4 x 1/1 GN pans	1400(W) x 650(D) x 900(H)			
MARBAIN4CC	Bain Marie w Cold Closet; 4 Division					

### Bain Marie - Free Standing - 5 Division (Excluding Inserts)

MARBAIN5HC	Bain Marie w Hot Closet; 5 Division	5 x 1/1 GN pans	1735(W) x 650(D) x 900(H)			
MARBAIN5CC	Bain Marie w Cold Closet; 5 Division					

### Bain Marie - Free Standing - 6 Division (Excluding Inserts)

MARBAIN6HC	Bain Marie w Hot Closet; 6 Division	6 x 1/1 GN pans	2069(W) x 650(D) x 900(H)			
MARBAIN6CC	Bain Marie w Cold Closet; 6 Division					

### Bain Marie - Accessories

MARBSG1	Sneeze Guard; S/Steel; Per Meter					
MARCN4	Casters; Set of 4; 100mm Nylon					
MARCS4	Casters; Set of 4; 100mm					

### Bain Marie Bridges

COACS113	Short Bain Marie Bridge					
COACS115	Long Bain Marie Bridge					

### Bain Marie - Table Top - 3 Division w Canopy

CATBSB3	Bain Marie 3 inserts with Canopy	Half Insert 4" x 3	W905 x D350 x H315	1.5Kw	220v	16Kg
---------	----------------------------------	--------------------	--------------------	-------	------	------

### Bain Marie - Table Top - 3 Division w Canopy

CATBSB4	Bain Marie 4 inserts with Canopy	Half Insert 4" x 4	W1170 x D350 x H316	1.5Kw	220v	22Kg
---------	----------------------------------	--------------------	---------------------	-------	------	------

### Bain Marie - Table Top - 3 Division w Canopy

CATBSB5	Bain Marie 5 inserts with Canopy	Half Insert 4" x 5	W1435 x D350 x H317	1.5Kw	220v	28Kg
---------	----------------------------------	--------------------	---------------------	-------	------	------

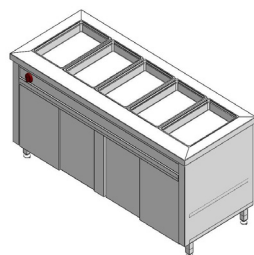
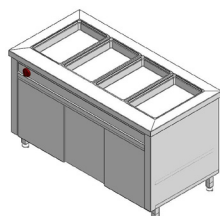
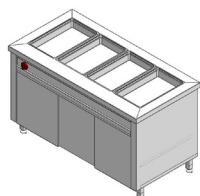
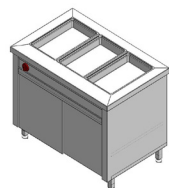

# Industrial Kitchen Equipment Catalogue

Order Code	Description	Capacity	Dimensions (mm)	Power	Voltage	Weight (KG)
------------	-------------	----------	-----------------	-------	---------	-------------



## Dip-Au-Lait

BCEDLA0002	Dip-Au-Lait; 2 x Divisions	4Lt	340 x 247 x 307	.125kW	230v	4kg
------------	----------------------------	-----	-----------------	--------	------	-----



## Food Warming Cabinet

CATDH-11-21	Food warming Cabinet	11 Racks	W780 x D960 x H1755	2.2kW	220v	130KG
-------------	----------------------	----------	---------------------	-------	------	-------

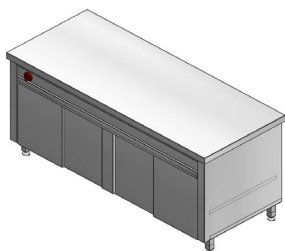

## Hot Closets - Freestanding

### Hot Closets - Free Standing

MARHC11	Hot Closet; 1100 x 680 x 900mm					
MARHC17	Hot Closet; 1700 x 680 x 900mm					
MARHC23	Hot Closet; 2300 x 680 x 900mm					

## Serving counters - Neutral - Not Heated

### With Doors

MARSC11	Hot Closet; 1100 x 680 x 900mm		1100(W) x 680(D) x 900(H)			
MARSC17	Hot Closet; 1700 x 680 x 900mm		1100(W) x 680(D) x 900(H)			
MARSC23	Hot Closet; 2300 x 680 x 900mm		1100(W) x 680(D) x 900(H)			

## Riser Shelves (Other sizes available)

### Single Cold Pass

MARRSC1	Single Heated Riser Shelf; Per meter		300mm Wide			
MARRSC2	Single Heated Riser Shelf; Per meter		300mm Wide			

### Single Hot Pass

MARRSH1	Single Heated Riser; per meter		300mm Wide			
MARRSH2	Double Heated Riser; per meter		300mm Wide			

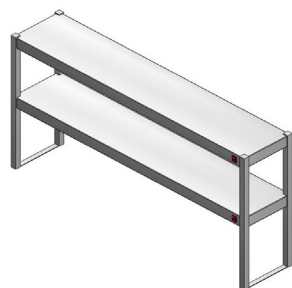

# Industrial Kitchen Equipment Catalogue

Order Code	Description	Capacity	Dimensions (mm)	Power	Voltage	Weight (KG)
------------	-------------	----------	-----------------	-------	---------	-------------

## Tray Slides

MARTSPM	Per meter					
MARTSCS	Corner Section					
MARTS11	1100 Tray Slide					
MARTS17	1700 Tray Slide					
MARTS23	2300 Tray Slide					

## Chip Dumps

### Chip Dump - Table Top

BCECDA0001	Chip Dump; Table Top		340 x 630 x 489	1kW	230V	7kg
------------	----------------------	--	-----------------	-----	------	-----



### Chip Dumps

CVCDT	Chip Dump; Table Top		425(W) x 650(D) x 740(H)	15 Amp	220V	
CVCDF	Chip Dump; Floor Standing		425(W) x 650(D) x 1400(H)			

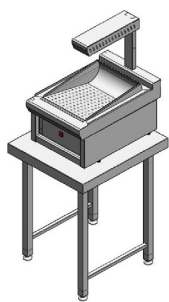

## Hot Food Displays

### Heated Display; Glass; Counter Top - Value Range

CATDH395	Heated Disply; Glass; 500	2 x levels	500 x 360 x 395	0.25kW	230V	80kg
----------	---------------------------	------------	-----------------	--------	------	------



### Heated Display; Counter Top - Value Range

CATRTR-WARM	Heated Disply; Glass; 856	160Lt	856 x 568 x 670	1500w	220v	56kG
-------------	---------------------------	-------	-----------------	-------	------	------



### Heated Display; Counter Top; Marble - Value Range

CATHW80	Heated Disply; Glass; 905		905 x 480 x 680	0.25kW	230V	80kg
---------	---------------------------	--	-----------------	--------	------	------



# Industrial Kitchen Equipment Catalogue

Order Code	Description	Capacity	Dimensions (mm)	Power	Voltage	Weight (KG)
------------	-------------	----------	-----------------	-------	---------	-------------

## Hot Food Displays



### Heated Displays

BCEDHC4900	Heated Display ; Table Top; 900	140Lt	900 X 540 X 790		230V	80kg
BCEDHC4200	Heated Display ; Table Top; 1200	190Lt	1200 X 540 X 790		230V	95kg
BCEDHC4500	Heated Display ; Table Top; 1500	240Lt	1500 X 540 X 790		230V	110kg



### Hot Food Bar - 2 Division

BCEBMA4002	Hot Food Bar, Two Divisions	2 x Divisions	734 x 653 x 728	2.4kW	230V	65kG
------------	-----------------------------	---------------	-----------------	-------	------	------



### Hot Food Bar - 3 Division

BCEBMA4003	Hot Food Bar, Three Divisions	3 x Divisions	1074 x 653 x 728	2.4kW	230V	95kG
------------	-------------------------------	---------------	------------------	-------	------	------



### Display Units - Countersunk

BCEDHC0900	DISPLAY UNIT HEATED - Countersunk - 900mm	2 Shelves; 70Lt	470 x 900 x 680		230V	50kG
BCEDHC1200	DISPLAY UNIT HEATED - Countersunk - 1200mm	2 Shelves; 94Lt	470 x 1200 x 680		230V	65kG
BCEDHC1500	DISPLAY UNIT HEATED - Countersunk - 1500mm	2 Shelves; 118Lt	470 x 1500 x 680		230V	80kG



### Display Units - Floor Standing

BCEDHC1900	DISPLAY UNIT HEATED - Floorstanding - 900mm	3 Shelves; 225Lt	900x 730 x 1200		230V	210Kg
BCEDHC2200	DISPLAY UNIT HEATED - Floorstanding - 1200mm	3 Shelves; 310Lt	1200x 730 x 1200		230V	255Kg
BCEDHC2500	DISPLAY UNIT HEATED - Floorstanding - 1500mm	3 Shelves; 395Lt	1500x 730 x 1200		230V	315Kg

# Industrial Kitchen Equipment Catalogue

Order Code	Description	Capacity	Dimensions (mm)	Power	Voltage	Weight (KG)
------------	-------------	----------	-----------------	-------	---------	-------------

## Buffet Servers

### Buffet Hot Unit - Counter Sunk - 2 Plate

CATHP2	BUFFET HOT UNIT - TWO PLATE - Counter Sunk Type		W835 x D690	1.3kW	220V	
--------	---	--	-------------	-------	------	--

### Buffet Hot Unit - Table Top - 2 Plate

CATSH2	BUFFET HOT UNIT - TWO PLATE - Table Top		W835 x D691 x H70			
--------	---	--	-------------------	--	--	--

### Buffet Hot Unit - Counter Sunk - 3 Plate

CATHP3	BUFFET HOT UNIT - THREE PLATE - Counter Sunk		W835 x D690	1.3kW	220V	
--------	--	--	-------------	-------	------	--

### Buffet Hot Unit - Table Top - 3 Plate

CATSH3	BUFFET HOT UNIT - THREE PLATE - Table Top		W835 x D691 x H70			
--------	---	--	-------------------	--	--	--

### Buffet Hot Unit - Table Top - 3 Plate

CATTC-1	HOT TRAY; Industrial; Takes Full size Gastronorm		W530 x D330 x H80		220V	10Kg
---------	--	--	-------------------	--	------	------

### Buffet Hot Unit - Table Top - 3 Plate

CATHP	HOT PLATE; w Overhead Light; Curved Glass; Stainless Steel		W1160 x D690 x D860	3kW	220V	46.4KG
-------	--	--	---------------------	-----	------	--------



# Industrial Kitchen Equipment Catalogue

Order Code	Description	Capacity	Dimensions (mm)	Power	Voltage	Weight (KG)
------------	-------------	----------	-----------------	-------	---------	-------------

## Carvery Units

### Carvery Unit - Single

CATB11-G	CARVERY UNIT -Single with overhead light		W500 x D470	250W	220V	
----------	--	--	-------------	------	------	--

### Carvery Unit - Double

CATB12-G	CARVERY UNIT - Double with overhead light		W770 x D750	250W x 2	220V	
----------	---	--	-------------	----------	------	--

### Carvery Unit with Sauce Bowls

CATCOMBOCA RV	CARVERY UNIT - w Overhead Light & 3 x Sauce Bowls		W610 x D760 x D650	3kW	220V	40.4kG
---------------	---	--	--------------------	-----	------	--------

### Carvery Unit - 2 Plate - Drop in Unit

CATCU2AG	CARVERY UNIT - TWO PLATE; <b>Drop In Unit</b>		W835 x D690	1.3kW	220V	
----------	---	--	-------------	-------	------	--

### Carvery Unit - 3 Plate - Drop in Unit

CATCU3AG	CARVERY UNIT - THREE PLATE; <b>Drop in Unit</b>		W1160 x D690	2.1kW	220V	
----------	---	--	--------------	-------	------	--

## PLATE WARMERS

### Plate Lowerators - Mobile

BCEPLK0001	Plate Lowerator / Warmer on wheels; Single Well	Approx 40	W450 x D450 x H847	.8Kw	230V	35kG
BCEPLK1002	Double	Approx 80	W450 x D910 x H770			70Kg

### Plate Lowerators - Countersunk

BCEPLK0001	Plate Lowerator / Warmer; Single; Counter Sunk; Cut diameter 385mm; Cabinet depth 730mm	40 to 50 Plates	405 diameter x 725			35kG
------------	---	-----------------	--------------------	--	--	------

### Plate Lowerators - Table Top

BCEPWK0001	Plate Warmer / Table top	Approx 60 plates	450 x 485 x 850	0.75kW	230V	34kG
------------	--------------------------	------------------	-----------------	--------	------	------



# Industrial Kitchen Equipment Catalogue

Order Code	Description	Capacity	Dimensions (mm)	Power	Voltage	Weight (KG)
------------	-------------	----------	-----------------	-------	---------	-------------

## Pie Warmers

### Pie Warmer - 2 Dozen - Value Range

CATR60-1	Pie Warmer; 2 Dozen	2 Doz	900 x 480 x 590	1.84kW	220v	38kG
----------	---------------------	-------	-----------------	--------	------	------

### Pie Warmer - 3 Dozen - Value Range

CATR60-2	Pie Warmer; 3 Dozen	3 Doz	660 x 437 x 655	1.84kW	220v	57kG
----------	---------------------	-------	-----------------	--------	------	------



### Pie Warmer

BCEPWK0002	Pie Warmer	Approx 30	660 x 465 x 645	1.84kW	230V	35kG
------------	------------	-----------	-----------------	--------	------	------



### Pie Warmer - Stainless Steel

BCEPWK0004	Pie Warmer S/Steel 640mm	Approx 30	640 x 333 x 525	1kW	230V	23kG
------------	--------------------------	-----------	-----------------	-----	------	------



## Pizza Display Heated

### Pie Warmer - 2 Dozen - Value Range

CATPZDH	Pizza Display Warmer; w Humidifier		500 x 450 x 770	850w	220v	30kG
---------	------------------------------------	--	-----------------	------	------	------



## Soup Kettles

### Soup Kettle - Black

BCESKD0008	SOUP KETTLE Black	11lt		.8kW	230V	
------------	-------------------	------	--	------	------	--



### Soup Kettle - Stainless Steel

BCESKD1008	SOUP KETTLE S/Steel	11lt		.8kW	230V	
------------	---------------------	------	--	------	------	--



# Industrial Kitchen Equipment Catalogue

Order Code	Description	Capacity	Dimensions (mm)	Power	Voltage	Weight (KG)
------------	-------------	----------	-----------------	-------	---------	-------------

## Urns



### Urns - Value Range

CATWB10	URN - 10Lt- Anti boil dry	10Lt			220V	10kG
CATWB15	URN - 15Lt - Anti boil dry	15LT			220V	10kG
CATWB20	URN - 20Lt - Anti boil dry	20Lt			220V	20kG
CATWB30	URN - 30Lt - Anti boil dry	30Lt			220V	25kG



### Urns - Anti Boil

BCEURB1012	URN Anti Boil 12Lt	12Lt				
BCEURB1016	URN Anti Boil 16Lt	16Lt				
BCEURB1020	URN Anti Boil 20Lt	20Lt				
BCEURB1030	URN Ante Boil 30Lt	30Lt				



### Water Boilers

CATBF-05	URN Aqua Boil 5Lt / Hour	5Lt / Hour	W430 x D178 x H290	1500W	220V	7.8kG
CATBF-10	URN Aqua Boil 10Lt / Hour	10Lt / Hour	W330 x D210 x H430	2000W	220V	9.8kG
CATBF-18	URN Aqua Boil 15Lt / Hour	15Lt / Hour	W400 x D250 x H520	3000W	220V	13kG
CATBF-30	URN Aqua Boil 30Lt / Hour	30Lt / Hour	W450 x D260 x H580	6000W	220V	15.2kG



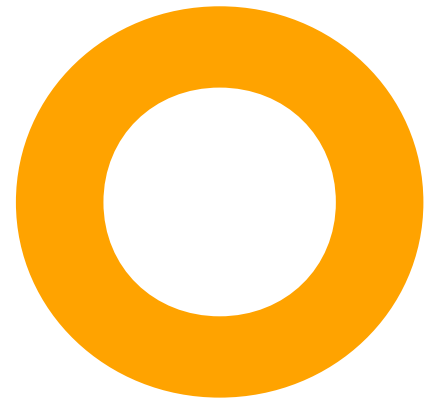

# Processing Equipment

# Industrial Kitchen Equipment Catalogue

Order Code	Description	Capacity	Dimensions (mm)	Power	Voltage	Weight (KG)
------------	-------------	----------	-----------------	-------	---------	-------------

## Band Saws



### Band Saw - Table Top - Value Range

CATBDSW	Band Saw; Table Top	4 to 180mm Thickness	W520 x D490 x H840	500w	220v	45kG
---------	---------------------	----------------------	--------------------	------	------	------



### Band Saw - Floor Standing - Value Range

CATJG400A	Band Saw; Floor Standing	30 to 350mm Thickness	W780 x D710 x H1690	1.5Kw	380V	98kG
-----------	--------------------------	-----------------------	---------------------	-------	------	------



### Band Saw - Table Top

BCESB6001	Band Saw; Table Top	210h x 250w cutting	610 x 650 x 1130	1.1kW	230V	92kG
-----------	---------------------	---------------------	------------------	-------	------	------



### Band Saw - Table Top

BCESB5003	Band Saw; Floor Standing		855 x 870 x 1800	1.5kW	380v; 3 Ph	220kg
-----------	--------------------------	--	------------------	-------	---------------	-------



## Biltong Slicer

BCESB2001	Biltong Slicer			.75kW	220V	14kg
BCEXBSV0002	Replacement Blade only					

# Industrial Kitchen Equipment Catalogue

Order Code	Description	Capacity	Dimensions (mm)	Power	Voltage	Weight (KG)
<b>Blenders &amp; Liquidisers</b>						



### Blender - 1.4lt - Economy

BCEICB1000	Blender; Avenia; 1.4Lt	1.4Lt	160 x 230 x 410	.9kW	220	4.1kG
BCEICB1001	Blender Jug; Avenia; 1.4Lt	1.4Lt				



### Blender - 1.3lt - Hamilton Beach

BCEBBH0908	Bar Blender P/Carb Jug	1.3lt				
------------	------------------------	-------	--	--	--	--



### Food Blender - 1.9lt

BCECBH0400	Food Blender Commercial; 1.9Lt	1.9lt	178 x 203 x 457	.75kW	220v	4.29kg
------------	--------------------------------	-------	-----------------	-------	------	--------



## Blenders & Liquidisers

### Food Blender - 1.8lt

BCEFBH6000	Food Blender P/Carb Jug 1.8lt	1.8Lt	178 x 203 x 467	1.2kW	220v	
------------	-------------------------------	-------	-----------------	-------	------	--



### Liquidiser - 4lt

BCELQS1004	Liquidiser; 4 Lt; zremovable Jug; Ideal for blending soups, sauces, etc	4Lt	210 x 240 x 600mm	0.7kW	220	
------------	---	-----	-------------------	-------	-----	--



## Bread Slicers

CATNFP31	Bread Slicer; Gravity Feed; Table Model		W650 x D750 x H740	250W	220V	52kG
CATNFP31ST	Bread Slicer; Stand		W560 x D570 x H900			17kG

# Industrial Kitchen Equipment Catalogue

Order Code	Description	Capacity	Dimensions (mm)	Power	Voltage	Weight (KG)
<b>Food Processors &amp; Vegetable Slicers/ Bowl Cutters/Mixers</b>						



### Bowl Cutter - 3Lt - Value Range

CATQS503A	Bowl Cutter	3Lt	W230 x D300 x H480	1.5kW	220v	32kG
-----------	-------------	-----	-----------------------	-------	------	------



### Bowl Cutter - 8Lt - Value Range

CATQS508A	Bowl Cutter	8Lt	W370 x D445 x H615	1.5kW	220v	56kG
-----------	-------------	-----	-----------------------	-------	------	------



### Bowl Cutter - Robo Coupe - 2.9lt

BCEBCR0002	Bowl Cutter; W s/Steel Bowl & smooth blade; single speed 1500rpm; 10 to 20 Servings	2.9Lt	350 x 200 x 280mm	550W	Single PH	
------------	---	-------	----------------------	------	--------------	--



### Bowl Cutter - Robo Coupe - 3.7lt

BCEBCR0003	Bowl Cutter; W s/Steel Bowl & smooth blade; single speed 1500rpm; 10 to 30 Servings	3.7Lt	400 x 210 x 320mm	650W	Single PH	
------------	---	-------	----------------------	------	--------------	--

# Industrial Kitchen Equipment Catalogue

Order Code	Description	Capacity	Dimensions (mm)	Power	Voltage	Weight (KG)
------------	-------------	----------	-----------------	-------	---------	-------------

## Food Processors & Vegetable Slicers/ Bowl Cutters/Mixers



Bowl Cutter - Robo Coupe - 11.5lt						
BCEBCR0010	Bowl Cutter; W s/Steel Bowl & smooth blade; two speed 1500rpm & 3000rpm; 50 to 200 Servings	11.5Lt	570 x 360 x 565mm	2200W	Three PH	



Bowl Cutter & Vegetable Slicer Combo - 2.9lt						
BCEFPR0201	Bowl Cutter and Vegetable combo; 2.9Lt Cutter bowl; Lid w two Hoppers; 2mm Slicer; 2mm Grater; 10 to 20 Servings	2.7Lt	495 x 220 x 280mm	550W Single Ph		



Bowl Cutter & Vegetable Slicer Combo - 3.7lt						
BCEFPR0301	Bowl Cutter and Vegetable combo; 3.7Lt Cutter bowl; Lid w 1 x 1/2 Moon & 1 x Cylindrical Hopper ; 2 & 4mm Slicer; 2mm Grater & Julienne 2x2 mm; 10 to 70 Servings	3.7Lt	180 x 255 x 290	650W Single Ph		



Bowl Cutter & Vegetable Slicer Combo - 5.9lt						
BCEFPR0502	Bowl Cutter and Vegetable combo; 5.9Lt S/Steel bowl; Lid w two Hoppers; 139cm <sup>2</sup> & Cylindrical	5.5Lt	180 x 255 x 290	1000W Three Ph		



Vegetable Mill - Economy						
BCEVMI0320	Vegetable Mill; Industrial; Stainless Steel; 200mm	200mm				



Vegetable Cutter w 5 Blades (Blades included in cost) - Value Range						
CATVGTR-21	Vegetable Preparation Machine; Incl Blades		w230 x d440 x h400	250w	220v	20kG
	3mm Grater					
	4mm Grater					
	7mm Grater					
	3mm Double Slicer					
	4mm Triple Slicer					
	10mm Cuber					

# Industrial Kitchen Equipment Catalogue

Order Code	Description	Capacity	Dimensions (mm)	Power	Voltage	Weight (KG)
<b>Vegetable Cutter w 5 Blades (Blades as per costs below)</b>						
BCEVCA0001	Vegetable Cutter w/5 x blades; Slicing 2mm; Serrated 5mm; Chipper 10mm; Julienne 6mm; Grating 4mm		440 x 250 x 590	0.36kW	230V	24.5kG
BCEVPC1103	Slicing 3mm (E3)					
BCEVPC1310	Chipper 10mm(B10)					
BCEVPC1212	Cubing 12mm(GC12)					
BCEVPC1403	Julienne 3mm (H3)					
BCEVPC1603	Grating 3mm (Z3)					



## Food Processors & Vegetable Slicers/ Bowl Cutters/Mixers

<b>Prep Machine</b>						
BCEVPR0030	Vegetable Preparation Machine; w removable Bowl & Lid; large hopper (104cm <sup>2</sup> ) and cylindrical hopper; 20 to 60 servings	120kg / h	590 x 320 x 304mm	500W Single Ph		



<b>Vegetable Prep Machine - 300kg / h - Robo Coupe</b>						
BCEVPR0050	Vegetable Preparation Machine; w removable Bowl & Lid; large 1/2 Moon hopper (227cm <sup>2</sup> ) and cylindrical hopper; 20 to 300 servings	300kg / h	590 x 350 x 320mm	550W Single Ph or 600W 3 PH		



## Food Mixers

<b>Immersion Mixer - Hand Held</b>						
BCEMMH1000	Immersion Mixer Hand Held		440 x 600 x 700	.175kW	220V	1.72kG



<b>Planetary Food Mixer - 5lt - Value Range</b>						
CATB5A	Food Mixer; 5Lt	5Lt	350 x 268 x 436	300w	220V	18kG



<b>Planetary Food Mixer - 5lt</b>						
BCEPMK0005	Planetary Food Mixer	5Lt	410 x 260 x 340	.32kW	220V	12.3kg



# Industrial Kitchen Equipment Catalogue

Order Code	Description	Capacity	Dimensions (mm)	Power	Voltage	Weight (KG)
<b>Planatory Food Mixers; (Incl Beater; Hook &amp; Whisk)</b>						
CATBM10N	Planatory Food Mixer; 10lt	10Lt	420 x 490 x 840	600w	220V	74kG
CATBM20N	Planatory Food Mixer; 20lt	20Lt	480 x 650 x 950	900w	220V	101kG
CATBM30N	Planatory Food Mixer; 30lt	30Lt	610 x 720 x 1120	1300w	220V	188kG
CATBM40N	Planatory Food Mixer; 40lt	40lt	540 x 660 x 1470	1300w	220V	212kG



<b>Dough Mixer - 20lt</b>						
CATSH20A	Dough Mixer	20Lt	830 x 530 x 880	1.5kW	220V	142kG



## Ice Crushers & Shavers

<b>Ice Crusher - Electric</b>						
BCEICH1001	Ice Crusher - Electric; Bowl optional Extra		200 x 230 x 300	0.65kW	230V	5.6kG



<b>Ice Shaver - Electric</b>						
BCEICH0945	Ice Shaver - Electric		700 x 160 x 245	.30kW	220v	12.9kG



<b>Ice Crusher - Hand</b>						
BCEICH0001	Ice Crusher - Hand		160 x 200 x 260			

## Juice Extractors

<b>Juice Extractor - Value Range</b>						
CATWFA3000	Juice Extractor Multi Purpose		340 X 340 X 365	370W	220V	3.68Kg



<b>Juice Extractor</b>						
BCEJES0001	Juice Extractor Multi Purpose		210 x 310 x 370	.24kW	220V	5kg



# Industrial Kitchen Equipment Catalogue

Order Code	Description	Capacity	Dimensions (mm)	Power	Voltage	Weight (KG)
<b>Milk Shake Machines</b>						



<b>Milk Shake Mixer - Single - Value Range</b>						
CATAK/2-2T	Milk Shake Mixer Single; includes 1 x cup			120W	220V	4.1Kg
<b>Milk Shake Cup - Value Range</b>						
CATAK1	Milkshake Cup					



<b>Milk Shake Mixer - Single</b>						
BCEMMH0200	Milk Shake Mixer Single; includes 1 x cup; Hamilton Beack		165 x 171 x 520	0.24kW	220V	6.5kG



<b>Milk Shake - Triple</b>						
BCEMMH0400	Milk Shake Mixer Triple	0.8Lt per Cup	270 x 270 x 500	240W	220V	8kG



<b>Milk Shake Cup - S/Steel</b>						
BCEMSC0001	Milkshake Cup S/Steell w Handle	880ml				

## Mincers - Electric



<b>Mincers - Electric - Value Range</b>						
CATELMNTJ12	Mincer - 120kg P/Hr	120kg P/Hour	450 x 220 x 340	550w	220v	31kG
CATELMNTJS22	Mincer 220kg P/Hr	220kg P/Hour	410 x 240 x 450	750w	220v	35kg



<b>Mincers - Electric</b>						
BCEMNT0022	Mincer - 200kg	180 - 200kg P/Hour	575 x 270 x 390	0.56kW	240V	18.5kg
BCEMNT0032	Mincer 250kg	250kg P/Hour	610 x 270 x 400	1.2kW	240V	35kg



# Industrial Kitchen Equipment Catalogue

Order Code	Description	Capacity	Dimensions (mm)	Power	Voltage	Weight (KG)
<b>Potato Peeling</b>						



### Potatoe Chipper Bridge

BCECBA0001	Potato Chipper bridge					
------------	-----------------------	--	--	--	--	--



### Potatoe Chipper

BCECHA0007	Potato Chipper; Requires bridge, to attach to vegetable sink, see below	12mm Square Chip				
------------	---	---------------------	--	--	--	--

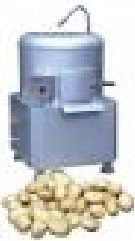

### Potatoe Peeler - Value Range

CATPP10	Potato peeler; 10Kg; on stand	10KG			220v	
CATPTPL15	Potato peeler; 15Kg	15KG	475 x 540 x 785	750w	220v	60kG
CATPTPL30	Potato peeler; 30Kg	30KG	850 x 530 x 800	1500w	220v	120kG



### Potatoe Peeler

BCEPPA0012	Potato peeler	12KG	780 x 420 x 1450	0.55kW	230V	
------------	---------------	------	---------------------	--------	------	--

## Sealing machines

### Sealer Machines - Value Range

CATKS200	Hand Impulse Sealer 200mm bar	Sealing Bar 200mm		330w	220v	
CATKS300	Hand Impulse Sealer 300mm bar	Sealing Bar 300mm		400w	220v	
CATKS400	Hand Impulse Sealer 400mm bar	Sealing Bar 400mm		600w	220v	
CATKS500	Hand Impulse Sealer 500mm bar	Sealing Bar 500mm		750w	220v	



### Sealer Machines

BCEHSM0200	Sealer Machine; Hand; Heat time 0-1.5sec	Sealing Bar 200mm	320 x 80 x 215	.26kW		2.3kg
BCEHSM0300	Sealer Machine; Hand; Heat time 0-1.5sec	Sealing Bar 300mm	430 x 80 x 255	.38kW		3.3kg
BCEHSM0400	Sealer Machine; Hand; Heat time 0-1.5sec	Sealing Bar 400mm	530 x 90 x 270	.52kW		4.8kg



Order Code	Description	Capacity	Dimensions (mm)	Power	Voltage	Weight (KG)
------------	-------------	----------	-----------------	-------	---------	-------------



### Vacuum Pack Machine

GLDZ260	Vacuum Pack Machine; In Chamber; 260mm; 1 sealing bar	Sealing lgth; 260mm	385 x 280 x 1200		220v	35kG
---------	---	---------------------	------------------	--	------	------



### Vacuum Pack Machine

GLDZ400	Vacuum Pack Machine; In Chamber; 400mm; 2 sealing bars	Sealing lgth; 400mm	540 x 480 x 1010		220v	110kG
---------	--	---------------------	------------------	--	------	-------

## Slicers

### Slicers - Value Range

CAT250ES/B10	Slicer 250mm	250mm Blade Diameter	470 x 280 x 380	180w	220v	18kG
CAT300ES/B12	Slicer 300mm	300mm Blade Diameter	530 x 330 x 460	250w	220v	25kG
CATSL350	Slicer 350mm	350mm Blade Diameter	680 x 515 x 470	380w	220v	36kG



### Slicers

BCESLS0220	Slicer 220mm	220mm Blade Diameter	470 X 420 X 340	0.15Kw	230V	15KG
BCESLA0250	Slicer 250mm	250mm Blade Diameter	530 X 430 X 375	0.19kW	230V	18kG
BCESLA0280	Slicer 280mm	280mm Blade Diameter	550 X 430 X 390	0.19kW	230V	20KG



## Wrapping Machine

### Wrapping Machine - Value Range

CATOT-202	Wrapping Machine				220V	
CATOT-203	Wrapping Machine				220V	

### Wrapping Machine

BCEWMW1380	Wrapping Machine S/Steel 380mm	380mm	463 x 670 x 158	0.175kW	220V	6kG
BCEWMW1500	Wrapping Machine S/Steel 500mm	500mm	583 x 670 x 158	0.21kW	220V	7kG



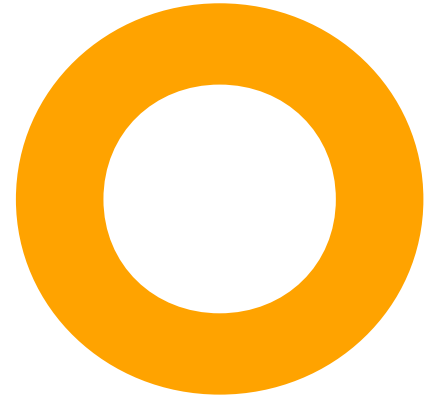

# Refrigeration Equipment

# Industrial Kitchen Equipment Catalogue

Order Code	Description	Capacity	Dimensions (mm)	Power	Voltage	Weight (KG)
------------	-------------	----------	-----------------	-------	---------	-------------

## Cold Bain Maries



Bain Marie - 4 Inserts						
CATBSB3	BAIN MARIE COLD - 4 Inserts; 0 - 35 C	4 x 1/3 Inserts 100mm	W1200 x D315 x H255		220V	32kG

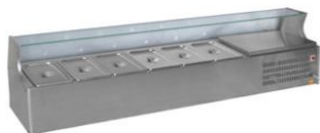

Bain Marie - 4 Inserts						
CATBSB4	BAIN MARIE COLD - 6 Inserts; 0 - 35 C	6 x 1/3 Inserts 100mm	W1500 x D315 x H256		220V	41kG



Bain Marie - 4 Inserts						
CATBSB5	BAIN MARIE COLD - 8 Inserts; 0 - 35 C	8 x 1/3 Inserts 100mm	W1800 x D315 x H257		220V	46kG

## Beverage Coolers



Beer Cooler - 2 Door						
CATSD250	Beer Cooler 2 Door; Fan cooling system; 0 to 10c;		W920 x D515 x H930		220v	72kG



Beer Cooler - 3 Door						
CATSD350	Beer Cooler 3 Door; Fan cooling system; 0 to 10c;	298Lt	W1385 x D515 x H930		220v	91kG

## Sliding Door



Beverage Cooler - 580lt						
JFMPM890SD	Fridge Beverage Cooler Sliding Door	580Lt	2020h x 890w x 630d		220v	



Beverage Cooler - 760lt						
JFMPM1140SD	Fridge Beverage Cooler Sliding Door	760Lt	2020h x 1140w x 630d		220V	



Beverage Cooler - 920lt						
JFMPM1360SD	Fridge Beverage Cooler Sliding Door	920Lt	2020h x 1360w x 630d			

# Industrial Kitchen Equipment Catalogue

Order Code	Description	Capacity	Dimensions (mm)	Power	Voltage	Weight (KG)
<b>Swing Door</b>						



<b>Beverage Cooler - 760lt</b>						
JFMPM240	Fridge Beverage Cooler Swing Door	1125Lt	1980h x 1280w x 750d			



<b>Beverage Cooler - 760lt</b>						
JFMPM120	Fridge Beverage Cooler Swing Door	545Lt	1980h x 635w x 750d			



<b>Beverage Cooler - Counter Top - 75lt</b>						
JFSCT-060SDX	Fridge - Counter top beverage cooler for the display and merchandising of juices and beverages	75Lt	835h x 535w x 460d			

## Cold Wells



<b>Cold Well - Static - 1200</b>						
CATCW3AG	COLDWELL STATIC - 1200		W1200 x D690	0.65kW	220V	



<b>Cold Well - Blown Air - 1200</b>						
CATBCW3AG	COLDWELL BLOWN AIR - 1200		W1200 x D690	0.65kW	220V	



<b>Cold Well - Static - 1800</b>						
CATCW5AG	COLDWELL STATIC - 1800		W1800 x D690	0.65kW	220V	



<b>Cold Well - Blown Air - 1800</b>						
CATBCW5AG	COLDWELL BLOWN AIR - 1800		W1800 x D690	0.65kW	220V	

# Industrial Kitchen Equipment Catalogue

Order Code	Description	Capacity	Dimensions (mm)	Power	Voltage	Weight (KG)
<b>Food Displays</b>						



### Cake Displays - Counter Top - Value Range

CATRT618L2	Cake Display; Counter Top	58Lt	491 x 440 x 888	130w	220v	55kG
------------	---------------------------	------	-----------------	------	------	------



### Cake Displays - Floor Standing - Value Range

CATG280L2	Cake Display; Counter Top ; Floor Model	280Lt	580 x 580 x 1930	550w	220v	92kG
-----------	---	-------	------------------	------	------	------



### Cake Display - Floor Standing - Rotating Shelves - Value Range

CATSCLG4-418S	Cake Display; Counter Top Floor Model; Rotating Shelves	418Lt	643 x 648 x 1850	620w	220v	120kG
---------------	---	-------	------------------	------	------	-------



### Cake Displays - Counter Top

BCECDF2000	<b>Cake</b> Display Fridge; <b>Counter Top</b> ; Rotating shelves	120lt	524 x 449 x 1083	.48kW	230V	60kg
BCECDF4000	<b>Cake</b> Display Fridge; <b>Counter Top</b> ; <b>Fixed</b> shelves	120lt	524 x 449 x 1083	.48kW	230V	60kg



### Cake Display - Floor Standing

BCECDF2001	<b>Cake</b> Display Fridge; Floor Standing	500lt	650 x 650 x 1790	.57kW	230V	110kg
------------	--	-------	------------------	-------	------	-------



### Display Fridges

CATHK-FD-3C6	Display Fridge - Freestanding, 600		640 740 1350	350w	220v	70kG
CATHK-FD-3C1	Display Fridge - Freestanding, 1000		1000 x 740 x 1350	516w	220v	90kG

# Industrial Kitchen Equipment Catalogue

Order Code	Description	Capacity	Dimensions (mm)	Power	Voltage	Weight (KG)
------------	-------------	----------	-----------------	-------	---------	-------------

## Food Displays

### Food Displays - Sushi - Single Tier - Value Range

CATG150L	Sushi Food Display; Single Tier	91Lt	1500 x 350 x 340	350w	220V	41kG
----------	---------------------------------	------	------------------	------	------	------

### Food Displays - Sushi - Double Tier - Value Range

CATG150LS	Sushi Food Display; Double Tier	150Lt	1500 x 370 x 520	450w	220V	55kG
-----------	---------------------------------	-------	------------------	------	------	------

### Food Displays - 6 Pan

BCESDF3006	Display 6 Pan; Silver; Pans Included	6 Pan	1523 x 417 x 246	1.5hp	220V	
BCESDF4006	Display 6 Pan; Black; Pans Included	6 Pan	1523 x 417 x 246	1.5hp	220V	

### Food Displays - 8 Pan

BCESDF3008	Display 8 Pan; Silver; Pans Included	8 Pan	1880 x 417 x 246	1.5hp	220V	
BCESDF4008	Display - 8 Pan; Black; Pans Included	8 Pan	1880 x 417 x 246	1.5hp	220V	

### Display Fridges - Free Standing - 1200 - Value Range

CATSLG4-80	Display Fridge; Marble; F/Standing; 905	80Lt	905 x 480 x 680	460w	220V	60kG
------------	---	------	-----------------	------	------	------

### Display Fridges - Free Standing - 1200 - Value Range

CATSLG4-378FH	Display Fridge; Marble; F/Standing; 1200	378Lt	1200 x 730 x 1210	690w	220V	150kG
---------------	--	-------	-------------------	------	------	-------

### Display Fridges - Free Standing - 1500 - Value Range

CATSLG4-480FH	Display Fridge; Marble; F/Standing; 1500	480Lt	1500 x 730 x 1210	810v	220V	180kG
---------------	--	-------	-------------------	------	------	-------

### Display Fridges - Free Standing - 1800 - Value Range

CATSLG4-580FH	Display Fridge; Marble; F/Standing; 1800	580Lt	1800 x 730 x 1210	910w	220V	220Kg
---------------	--	-------	-------------------	------	------	-------

### Display Fridges - Free Standing

BCEDFC0900	Display Fridge - Freestanding, 900mm	225Lt	730 x 900 x 1200		230V	220Kg
BCEDFC1200	Display Fridge - Freestanding, 1200mm	310Lt	730 x 1200 x 1200		230V	270Kg
BCEDFC1500	Display Fridge - Freestanding, 1500mm	395Lt	730 x 1500 x 1200		230V	330Kg

### Display Fridges - Countersunk

BCEDFC1900	Display Fridge - Countersunk, 900mm	70lt	900 x 470 x 680		230V	60kg
BCEDFC2200	Display Fridge - Countersunk, 1200mm	94lt	1200 x 470 x 680		230V	75kg
BCEDFC2500	Display Fridge - Countersunk, 1500mm	118lt	1500 x 470 x 680		230V	90kg

### Display Fridges - Countertop

BCEDFC4900	Display Fridge - Countertop, 900mm	140lt	900 x 540 x 790		230V	90kg
BCEDFC4200	Display Fridge - Countertop, 1200mm	190lt	1200 x 540 x 790		230V	115kg
BCEDFC4500	Display Fridge - Countertop, 1500mm	240lt	1500 x 540 x 790		230V	140kg

### Display Fridges - Floor Standing

BCEDFC5900	Display Fridge - Floor Standing, 900mm	302lt	720 x 900 x 1200		230V	215kg
BCEDFC5200	Display Fridge - Floor Standing, 1200mm	417lt	720 x 1200 x 1200		230V	260kg
BCEDFC5500	Display Fridge - Floor Standing, 1500mm	532lt	720 x 1500 x 1200		230V	300kg

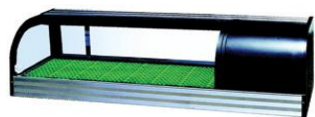

# Industrial Kitchen Equipment Catalogue

Order Code	Description	Capacity	Dimensions (mm)	Power	Voltage	Weight (KG)
<b>Undercounter Fridges</b>						



### Stainless Steel Swing Door; Self Contained Cabinet

JFQUB4S/C	1.5 Door		W1180 x D750 x H915		220V	
JFQUB6S/C	2.5 Door		W1780 x D750 x H915		220V	
JFQUB8S/C	3.5 Door		W2380 x D750 x H915		220V	



### Glass Swing Door; Self Contained Cabinet; casters optional;

JFGD4S/C	1.5 Door		W1180 x D750 x H915		220V	
JFGD6S/C	2.5 Door		W1780 x D750 x H915		220V	
JFGD8S/C	3.5 Door		W2380 x D750 x H915		220V	



### Glass Sliding Door; Self Contained Cabinet; casters optional

JFGD6SL/D	2 Door		W1180 x D750 x H915		220V	
JFGD8SL/D	4 Door		W1780 x D750 x H915		220V	



### Pizza Top; S/Steel Swing Door; Self Contained Cabinet

JFQUB4PZTS/C	1.5 Door; 6 X 1/6 Inserts included		W1180 x D750 x H915		220V	
JFQUB6PZTS/C	2.5 Door; 10 x 1/6 Inserts included		W1780 x D750 x H915		220V	
JFQUB8PZTS/C	3.5 Door; 12 x 1/6 Inserts included		W2380 x D750 x H915		220V	



### Polar top; S/Steel Swing Door; Self Contained Cabinet

Fitted with 2 compressors: 1 compressor refrigerates the cabinet and 1 compressor refrigerates the polar top.

JFQUB4PLTS/C	1.5 Door		W1180 x D750 x H915		220V	
JFQUB6PLTS/C	2.5 Door		W1780 x D750 x H915		220V	
JFQUB8PLTS/C	3.5 Door		W2380 x D750 x H915		220V	



### S/Steel Roll Top; Self Contained Cabinet

JFQUB4PLTS/C	2 Door		W1180 x D750 x H915		220V	
JFQUB6PLTS/C	3 Door		W1780 x D750 x H915		220V	
JFQUB8PLTS/C	4 Door		W2380 x D750 x H915		220V	



## Under Counter Freezer

### Underbar Freezer, S/Steel Swing Door; Self Contained Cabinet; Holding cabinet only; -14°

JFFUB6S/C	2 Door		W1180 x D750 x H915		220V	
-----------	--------	--	---------------------	--	------	--



# Industrial Kitchen Equipment Catalogue

Order Code	Description	Capacity	Dimensions (mm)	Power	Voltage	Weight (KG)
<b>Upright Fridges &amp; Freezers</b>						



<b>Upright Fridges &amp; Freezers - Glass Door</b>						
CATDBQ318L	<b>Fridge</b> Upright; Glass Door;	318Lt	600 x 600 x 1890		220V	40kG
CATDBQ318F	<b>Freezer</b> Upright; Glass Door; -22-.18°	318Lt	600 x 600 x 1890		220V	40kG



<b>Upright Fridges &amp; Freezers; 2 Door</b>						
CATHR600	<b>Fridge</b> Upright	570Lt	W770 x D750 x H1900		220V	
CATHF600	<b>Freezer</b> Upright	555Lt	W600 x D600 x H1890		220V	



<b>Upright Fridges &amp; Freezers</b>						
CATGN70TNV	<b>Fridge</b> Upright; 3 x shelves; -2 to +8; S/Steel	597Lt	W740 x D830 x H2010		220V	137kG
CATGN70BTV	<b>Freezer</b> Upright; 3 x shelves; -22 to -18; S/Steel	597Lt	W740 x D830 x H2010		220V	138kG



<b>Upright Fridges &amp; Freezers - Double Door</b>						
CATGN140TNV	<b>Fridge</b> Upright; 3 x shelves; -2 to +8; S/Steel	1325Lt	W1480 x D830 x H2010		220V	198kG
CATGN140TV	<b>Freezer</b> Upright; 3 x shelves; -22 to -18; S/Steel	1325Lt	W1480 x D830 x H2010		220V	208kG



<b>Freezer / Cold Rooms</b>						
GLCOL0180	COLD ROOM; 1.8 x 1.8 x 2.4; Chromodek; Excludes Installation		1800 x 1800 x 2400			
GLCOL0240	COLD ROOM; 2.4 x 2.4 x 2.4; Chromodek; Excludes Installation		2400 x 2400 x 2400			
GLCOL030	COLD ROOM; 3.0 x 3.0 x 2.4; Chromodek; Excludes Installation		3000 x 3000 x 2400			
GLCOL0180	FREEZER ROOM; 1.8 x 1.8 x 2.4; Chromodek; Excludes Installation		1800 x 1800 x 2400			
GLCOL0240	FREEZER ROOM; 2.4 x 2.4 x 2.4; Chromodek; Excludes Installation		2400 x 2400 x 2400			
GLCOL030	FREEZER ROOM; 3.0 x 3.0 x 2.4; Chromodek; Excludes Installation		3000 x 3000 x 2400			

# Industrial Kitchen Equipment Catalogue

Order Code	Description	Capacity	Dimensions (mm)	Power	Voltage	Weight (KG)
<b>Ice Cream Machines</b>						



<b>Ice Cream Machine - Floor Standing</b>						
GLWF168SD	ICE CREAM MACHINE; 3 x Flavours; 180 cones per hour	25Lt / h	455 x 695 x 1228	1.6kW		156kG

<b>Ice Cream Machine - Table Top</b>						
GLOPF3331D	ICE CREAM MACHINE; Table Top; 1 x Flavours;					

## Ice Machines



<b>Ice Machine - 22kg - Value Range</b>						
GLAZ22	Ice Maker 22kg / 24h; 8kG Storage	22kG / 24h	360 x 470 x 603	360W	220V	35kG



<b>Ice Machine - 28kg</b>						
BCEIMB0028	Ice Maker 28kg / 24h; 9kG Storage	28kG / 24h	390 x 460 x 690	.37kW	220V	44kG



<b>Ice Machine - 33kg</b>						
BCEIMB0033	Ice Maker 33kg / 24h; 16kG Storage	33kG / 24h	500 x 580 x 690	.37kW	220V	56kG



<b>Ice Machine - 46kg</b>						
BCEIMB0046	Ice Maker 46kg / 24h; 25kG Storage	46kG / 24h	500 X 580 X 800	.05kw	220V	64kg



<b>Ice Machines - 200 to 500kg - Value Range</b>						
GLAZ200L	Ice Maker 200kg / 24h; Bin size 180kG; Includes bin	200kG / 24h	762 x 610 x 530	1.4kWW		60kG
GLAZ300L	Ice Maker 300kg / 24h; Bin size 180kG; Includes bin	300kG / 24h	762 x 610 x 530	1.4kw		68kG
GLAZ500L	Ice Maker 500kg / 24h; Bin size 180kG; Includes bin	500kG / 24h	762 x 610 x 530	2.05kW		81kG

# Industrial Kitchen Equipment Catalogue

Order Code	Description	Capacity	Dimensions (mm)	Power	Voltage	Weight (KG)
<b>Juice &amp; Slush Dispensers</b>						



<b>Juice Dispenser - Single - Value Range</b>						
CATLYJ-20L	Juice Dispenser; Single Bowl; Electric	20Lt x 2	240 x 470 x 570	210w	220V	20kG



<b>Juice Dispenser - Double - Value Range</b>						
CATLYJ-20Lx2	Juice Dispenser; Double Bowl; Electric	20Lt x 3	360 x 470 x 570	350w	220V	35kG



<b>Juice Dispenser - Triple - Value Range</b>						
CATLYJ-20Lx3	Juice Dispenser; Triple Bowl; Electric	20Lt x 3	540 x 470 x 570	450w	220V	48kG



<b>Juice Dispenser - Double</b>						
BCEJDA2002	Juice Dispenser; Double Bowl	14Lt x 2	525 x 350 x 720	350W	220V	31kg



<b>Juice Dispenser - Triple</b>						
BCEJDA2003	Juice Dispenser; Triple Bowl	14Lt x 3	775 x 350 x 720	400W	220V	40kg

# Industrial Kitchen Equipment Catalogue

Order Code	Description	Capacity	Dimensions (mm)	Power	Voltage	Weight (KG)
<b>Juice &amp; Slush Dispensers</b>						



### Slush Machine - Double - Value Range

CATHT2ML	Slush Machine; Triple Bowl	12Lt x 3	W600 x D560 x H850	1420W	220V	100kg
----------	----------------------------	----------	--------------------	-------	------	-------

### Slush Machine - Triple - Floor Model - Value Range

CATHT3ML	Slush Machine; Triple Bowl	12Lt x 3	W600 x D560 x H850	1420W	220V	100kg
----------	----------------------------	----------	--------------------	-------	------	-------



### Slush Machine - Double

BCESMS0002	Slush Machine; Double Bowl	12Lt x 2	W400 x D560 x H850	940W	220V	60kg
------------	----------------------------	----------	--------------------	------	------	------



### Slush Machine - Triple

BCESMS0003	Slush Machine; Triple Bowl	12Lt x 3	W600 x D560 x H850	1420W	220V	100kg
------------	----------------------------	----------	--------------------	-------	------	-------

## Pizza Ingredient Chillers

CATVRX2000	Pizza Ingredient Chiller; Counter Top; w Inserts; 1400	9 x 1/4 GN Inserts	1400 x 335 x 440		220v	27KG
CATVRX1400	Pizza Ingredient Chiller; Counter Top; w Inserts; 2000	9 x 1/4 GN Inserts	2000 x 335 x 440		220v	



## Salad Bars

JFSBAR130	SALAD BAR, 2.5m, Includes 14 x bowls and Lids	14 inserts	2.5m			
JFSBAR250	SALAD BAR, 1.3m, Includes 8 x bowls and Lids	8 inserts	1.3m			



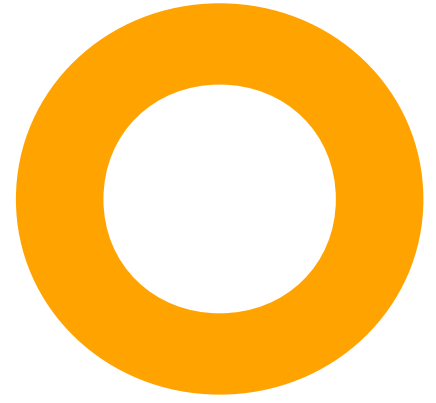

# Dishwashers & Accessories

# Industrial Kitchen Equipment Catalogue

Order Code	Description	Dimensions (mm)	Power	Voltage	Weight (KG)
------------	-------------	-----------------	-------	---------	-------------

## Dishwashers

### Hood Dishwasher



BCEDWD0011	Dish washer W/Hood (Excl Inlet / Outlet Tables) ; Gravity Drain; Requires fitted chemical dispenser; Approx; 60 Racks per Hour; <b>Note:</b> Gravity drain, and requires a chemical dispenser to be fitted by client chemical supplier	720 x 735 x 1400 /1890	13.12kW	400V-3 Phase + N	116kG
------------	--	------------------------	---------	------------------------	-------



### Tunnel Dishwasher

BCEDWT0161	Dish washer - Tunnel (Excl Inlet / Outlet Tables)  <b>Note:</b> Gravity drain, and requires a chemical dispenser to be fitted by	1080 x 715 x 1900	23kW		
------------	--	-------------------	------	--	--

## Under Counter Dish & Glass Washers

### Glass Washer



BCEGWD1000	<b>Glass Washer</b> under counter; <b>Basket size 350 x 350mm</b> ; max Glass/Plate height 195mm; Includes 2 x Mesh rack; 1 x Plate rack; 1 x cutlery Holder; <b>Gravity Drain; Requires chemical dispenser</b>	400 x 470 x 585	2.1kW	220V	33kG
------------	---	-----------------	-------	------	------

### Accessories

BCEGWD1035	Mesh rack; 350 x 350mm				
BCEGWD2001	Small Plate Rack				
BCEDRC5004	Cutlery Holder				



### Dish Washer - Basket Size 400

BCEDWD0400	<b>Dish Washer</b> under counter; <b>Basket size 400 x 400mm</b> ; <b>max glass height 290mm</b> ; Includes 2 x Mesh/Glass rack; 1 x Plate rack; 1 x cutlery; <b>Gravity Drain; Requires chemical dispenser</b>	450 x 530 x 700	3.05kW	220V	43kG
------------	---	-----------------	--------	------	------

### Accessories

BCEDWD2040	Plate rack; 400 x 400mm				
BCEDWD3040	Glass Rack; 400 x 400mm				
BCEDRC5004	Cutlery Holder				



### Dish Washer - Basket Size 500

BCEDWD0500	<b>Dish Washer</b> under counter; <b>Basket size 500 x 500mm</b> ; <b>max glass / Plate height 325mm</b> ; Includes; 1 x Plate rack; 1 x Glass rack; 1 x cutlery; <b>Gravity Drain; Requires chemical dispenser</b>	590 x 600 x 850	3.45kW	220V	65kG
------------	---	-----------------	--------	------	------

# Industrial Kitchen Equipment Catalogue

Order Code	Description	Dimensions (mm)	Power	Voltage	Weight (KG)
------------	-------------	-----------------	-------	---------	-------------

## Dishwasher Tables

Tables are available in different sizes. Product codes below are for 430 S/Steel; 0.9mm; Other S/S grades are available; Outlet available in double tier or mushroom shelf, Dirties table available in double tier

### Dirties Table

MARDT11	Dirties Table; 1200	1100(W) X 620(D) X 900(H)			
MARDT17	Dirties Table; 1600	1700(W) X 620(D) X 900(H)			
MARDTRB	Dirties Table; 1800	2300(W) X 620(D) X 900(H)			

### Inlet Table

MARIT11	Inlet Table; 1200; w rinse bowl & splash guard	1100(W) X 620(D) X 900(H)			
MARIT17	Inlet Table; 1600 w rinse bowl & splash guard	1700(W) X 620(D) X 900(H)			
MARIT23	Inlet Table; 1800 w rinse bowl & splash guard	2300(W) X 620(D) X 900(H)			

### Outlet Table

MAROT11	Outlet Table; 1200	1200(W) X 620(D) X 900(H)			
MAROT17	Outlet Table; 1600	1600(W) X 620(D) X 900(H)			
MAROT23	Outlet Table; 1800	1800(W) X 620(D) X 900(H)			

## Dishwasher Accessories

### Refuse Bin

BCEIBP1085	Refuse Bin to go under Dirties table; under ring for scraping off left overs; 85 Lt	450 x 630mm			
------------	---	-------------	--	--	--

### Dolley for Refuse Bin

BCEIBP0001	Dolley for Refuse bin				
------------	-----------------------	--	--	--	--

### Pre Rinse Spray

BCEPRS0001	Pre rinse spray				
------------	-----------------	--	--	--	--

### Cutlery Holder

BCEDRC5004	Dish Washer Cutlery Holder				
------------	----------------------------	--	--	--	--

### Flatware / Bowl Rack

BCEDRB5001	Flatware / Bowl Rack	500 x 500			
BCEDRE5001	Open Extender	40mm			

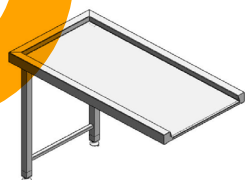
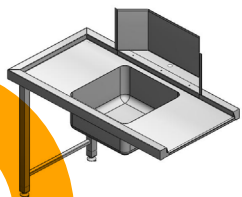

# Industrial Kitchen Equipment Catalogue



Order Code	Description	Dimensions (mm)	Power	Voltage	Weight (KG)
------------	-------------	-----------------	-------	---------	-------------



<b>Flatware / Cutlery Rack</b>					
BCEDRC5001	Flatware / Cutlery Rack	500 x 500			
BCEDRE5001	Open Extender	40mm			



<b>All Purpose / Plate Rack</b>					
BCEDRA5001	All Purpose / Plate Rack	500 x 500			
BCEDRE5001	Open Extender	40mm			



<b>Glass Rack - 9</b>					
BCEGRC5009	Glass Rack x 9; Interior dimensions 150 x 150 x 80mm	500 x 500			
BCEGRE5009	Extender; 9 compartment	40mm			



<b>Glass Rack - 16</b>					
BCEGRC5016	Glass Rack x 16; Interior dimensions 110 x 110 x 80mm	500 x 500			
BCEGRE5016	Extender; 16 compartment	40mm			



<b>Glass Rack - 20</b>					
BCEGRC5020	Glass Rack x 20; Interior dimensions 110 x 90 x 80mm	500 x 500			
BCEDRE5001	Open Extender	40mm			



<b>Glass Rack - 25</b>					
BCEGRC5025	Glass Rack x 25; Interior Dimensions 90 x 90 x 60mm	500 x 500			
BCEGRE5025	Extender; 25 compartment	40mm			



<b>Glass Rack - 36</b>					
BCEGRC5036	Glass Rack x 36; Interior Dimensions 75 x 75 x 80mm	500 x 500			
BCEGRE5036	Extender; 36 compartment	40mm			



<b>Glass Rack - 49</b>					
BCEGRC5049	Glass Rack x 49; Interior Dimensions 65 x 65 x 80mm	500 x 500			
BCEGRE5036	Extender; 49 compartment	40mm			



<b>Rack Trolley</b>					
BCEDRC4002	Rack Dolley				



<b>Rack Dust Cover</b>					
BCERDC0122	Rack Dust Cover; 1220mm; Heavy Duty vinyl keeps glassware clean during storage	1220mm			



# Industrial Kitchen Equipment Catalogue

Order Code	Description	Dimensions (mm)	Power	Voltage	Weight (KG)
------------	-------------	-----------------	-------	---------	-------------



Glass Washer - Manual					
BCEGWH2003	Glass Washer Manual 3 Head	200mm			



Trolleys - Dirties					
COADC293	Dirties Trolley; With 4 Bins; 760 x 540 x 845				
COAPB	Extra Plastic Bins				



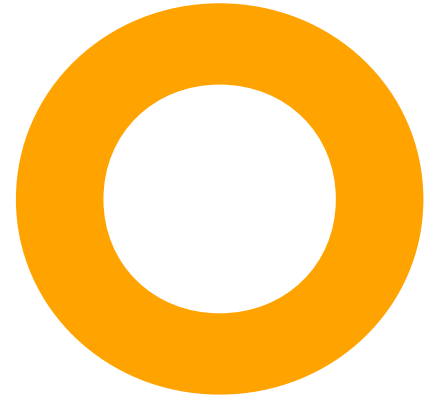

# Sinks & Wash Basins

# Industrial Kitchen Equipment Catalogue

Order Code	Description	Dimensions (mm)
------------	-------------	-----------------

## Stainless Steel Prep Sinks

### Single Bowl Prep Sinks - Galv Legs - Value Range

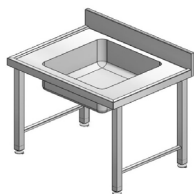

MARSPS11	Single Prep Sink; S/Steel;;1100	1100(W) x 680(D) x 900(H)
MARSPS11S	Single Prep Sink; S/Steel;;1100; w Galv Shelf	
MARSPS11HS	Single Prep Sink; S/Steel;;1100; w H/Duty Galv Shelf	
MARSPS17	Single Prep Sink; S/Steel;;1700	1700(W) x 680(D) x 900(H)
MARSPS17S	Single Prep Sink; S/Steel;;1700; w Galv Shelf	
MARSPS17HS	Single Prep Sink; S/Steel;;1700; w H/Duty Galv Shelf	

### Double Bowl Prep Sinks - Galv Legs - Value Range



MARDPS17	Double Prep Sink; S/Steel;; 1700	1700(W) x 680(D) x 900(H)
MARDPS17S	Double Prep Sink;; S/Steel;; 1700; w Galv Shelf	
MARDPS17HS	Double Prep Sink;; S/Steel;; 1700; w H/Duty Galv Shelf	
MARDPS23	Double Prep Sink; S/Steel;; 2300	2300(W) x 680(D) x 900(H)
MARDPS23S	Double Prep Sink;; S/Steel;; 2300; w Galv Shelf	
MARDPS23HS	Double Prep Sink;; S/Steel;; 2300; w H/Duty Galv Shelf	

### Single Bowl Prep Sinks - S/Steel Legs



MARSPSS11	Single Prep Sink; S/Steel;;1100	1100(W) x 680(D) x 900(H)
MARSPSS11S	Single Prep Sink; S/Steel;;1100; w Galv Shelf	
MARSPSS11HS	Single Prep Sink; S/Steel;;1100; w H/Duty Galv Shelf	
MARSPSS17	Single Prep Sink; S/Steel;;1700	1700(W) x 680(D) x 900(H)
MARSPSS17S	Single Prep Sink; S/Steel;;1700; w Galv Shelf	
MARSPSS17HS	Single Prep Sink; S/Steel;;1700; w H/Duty Galv Shelf	

### Double Bowl Prep Sinks - S/Steel Legs

MARDPSS17	Double Prep Sink; S/Steel;; 1700	1700(W) x 680(D) x 900(H)
MARDPSS17S	Double Prep Sink;; S/Steel;; 1700; w Galv Shelf	
MARDPSS17HS	Double Prep Sink;; S/Steel;; 1700; w H/Duty Galv Shelf	
MARDPSS23	Double Prep Sink; S/Steel;; 2300	2300(W) x 680(D) x 900(H)
MARDPSS23S	Double Prep Sink;; S/Steel;; 2300; w Galv Shelf	
MARDPSS23HS	Double Prep Sink;; S/Steel;; 2300; w H/Duty Galv Shelf	

## Stainless Steel Pot Sinks

### Single Bowl Pot Sinks - Galv Legs - Value Range

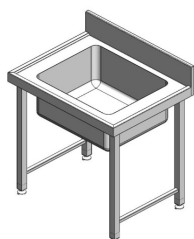

MARSPTS9	Single Pot Sink; S/Steel;; 900	900(W) x 680(D) x 900(H)
MARSPTS9T	Single Pot Sink; S/Steel;; 900; w M/Steel Tubular Shelf	
MARSPTS9ST	Single Pot Sink; S/Steel;; 900; w S/Steel Tubular Shelf	
MARSPTS17	Single Pot Sink; S/Steel;; 1700	1700(W) x 680(D) x 900(H)
MARSPTS17T	Single Pot Sink; S/Steel;; 1700; w M/Steel Tubular Shelf	
MARSPTS17ST	Single Pot Sink; S/Steel;; 1700; w S/Steel Tubular Shelf	

### Double Bowl Pot Sinks - Galv Legs - Value Range



MARDPTS17	Double Pot Sink; S/Steel;; 1700	1700(W) x 680(D) x 900(H)
MARDPTS17T	Double Pot Sink; S/Steel;; 1700; w M/Steel Tubular Shelf	
MARDPTS17ST	Double Pot Sink; S/Steel;; 1700; w S/Steel Tubular Shelf	
MARDPTS123	Double Pot Sink; S/Steel;; 2300	2300(W) x 680(D) x 900(H)
MARDPTS23T	Double Pot Sink; S/Steel;; 2300; w M/Steel Tubular Shelf	
MARDPTS23ST	Double Pot Sink; S/Steel;; 2300; w S/Steel Tubular Shelf	

# Industrial Kitchen Equipment Catalogue

Order Code	Description	Dimensions (mm)
<b>Stainless Steel Pot Sinks</b>		

## Single Bowl Pot Sinks - S/Steel Legs

MARSPTSS9	Single Pot Sink; S/Steel;; 900	900(W) x 680(D) x 900(H)
MARSPTSS9ST	Single Pot Sink; S/Steel;; 900; w S/Steel Tubular Shelf	
MARSPTSS17	Single Pot Sink; S/Steel;; 1700	1700(W) x 680(D) x 900(H)
MARSPTSS17ST	Single Pot Sink; S/Steel;; 1700; w S/Steel Tubular Shelf	



## Double Bowl Pot Sinks - S/Steel Legs

MARDPTSS17	Double Pot Sink; S/Steel;; 1700	1700(W) x 680(D) x 900(H)
MARDPTSS17ST	Double Pot Sink; S/Steel;; 1700; w S/Steel Tubular Shelf	
MARDPTSS23	Double Pot Sink; S/Steel;; 2300	2300(W) x 680(D) x 900(H)
MARDPTSS23ST	Double Pot Sink; S/Steel;; 2300; w S/Steel Tubular Shelf	

## Stainless Steel Combination Sinks

### Combination Sinks - Galv Legs - Value Range

MARCS17	Combination Sink; S/Steel;; 1700	1700(W) x 680(D) x 900(H)
MARCS17S	Single Prep Sink; S/Steel;; 1700; with Flat Shelf	
MARCS17HS	Single Prep Sink; S/Steel;; 1700; with H/Duty Flat Shelf	
MARCS17T	Single Prep Sink; S/Steel;; 1700; with M/Steel Tubular Shelf	
MARCS23	Single Prep Sink; S/Steel;; 2300	2300(W) x 680(D) x 900(H)
MARCS23S	Single Prep Sink; S/Steel;; 2300; with Flat Shelf	
MARCS23HS	Single Prep Sink; S/Steel;; 2300; with H/Duty Flat Shelf	
MARCS23T	Single Prep Sink; S/Steel;; 2300; with M/Steel Tubular Shelf	



### Combination Sinks - S/Steel Legs

MARCSS17	Combination Sink; S/Steel;; 1700	1700(W) x 680(D) x 900(H)
MARCSS17S	Single Prep Sink; S/Steel;; 1700; with Flat Shelf	
MARCSS17HS	Single Prep Sink; S/Steel;; 1700; with H/Duty Flat Shelf	
MARCSS17ST	Single Prep Sink; S/Steel;; 1700; with S/Steel Tubular Shelf	
MARCSS23	Single Prep Sink; S/Steel;; 2300	2300(W) x 680(D) x 900(H)
MARCSS23S	Single Prep Sink; S/Steel;; 2300; with Flat Shelf	
MARCSS23HS	Single Prep Sink; S/Steel;; 2300; with H/Duty Flat Shelf	
MARCSS23ST	Single Prep Sink; S/Steel;; 2300; with S/Steel Tubular Shelf	

## Wash Basins

### Vanity Sink

CATSHY-1	Vanity Sink; 304 Stainless Steel; w Brackets	W535 x D420 x H150
----------	--	--------------------



### Knee Operated Wash Basin in Cabinet

CATHC-10	Knee Operated Wash Hand Basin with Splash Back	W400 x D400
----------	--	-------------

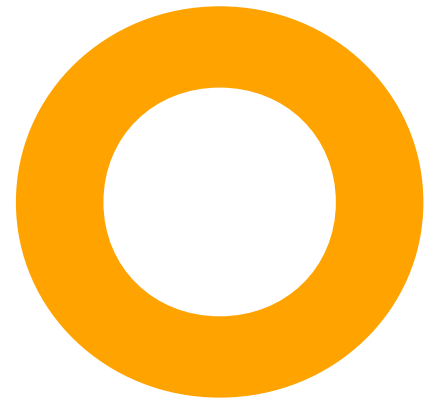

# Tables, Shelving & Racking

# Industrial Kitchen Equipment Catalogue

Order Code	Description
------------	-------------



Chopping Block	
BCEBBP0610	Butcher Block and Stand PE; 610 x 610 x 40mm
BCEBBS0610	Butcher Block Stand; Mild Steel
BCECBP0610	Cutting Board PE; 610 x 610 x 40mm



## Crockery Racks

Economy	
BCECRM2130	300 PCS Mobile 1130 x 600 x 950
BCECRM0830	400 PCS Mobile 830 x 600 x 1700
BCECRM1130	600 PCS Mobile 1130 x 600 x 1700



Heavy Duty	
COACC577	200 PCS Mobile; <b>Heavy Duty</b> ; 850 x 625 x 1000H
COACC574	400 PCS Mobile; <b>Heavy Duty</b> ; 850 x 625 x 1635H

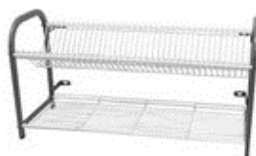

Wall Mounted	
BCECRW0806	Wall Mounted 802mm; 38 plates
BCECRW1105	Wall Mounted 1105mm; 53 plates
BCECRW2806	Wall Mounted 802mm; 3 x shelves
BCECRW2105	Wall Mounted 1105mm; 3 x shelves

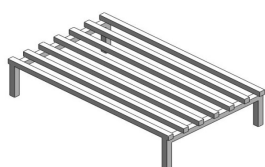

## Dunnage Racks

MARDRMS10	Dunnage Rack; M/Steel; 1000 x 650 x 150mm
CVDR90	Dunnage Rack; S/Steel; 900 x 600 x 250mm
CVDR12	Dunnage Rack; S/Steel; 1200 x 600 x 250mm



TJPP862	Plastic Pallets; 800 x 600 x 200mm
---------	------------------------------------



Floor Interlocking Rack System	
BCEFRS0001	Interlocking modular floor system; provided raised floor in storage areas; Polyethylene; dishwasher safe

# Industrial Kitchen Equipment Catalogue

Order Code	Description
<b>Pot Racks</b>	



<b>Floor Standing</b>	
BCEPRF1200	Pot Rack; Floor Standing; S/Steel; 1200 x 600 x 1450;
CVPRF	<b>Pot Rack; Floor Standing;</b> S/Steel; 1200 x 600 x 1450; Frame 304 S/S
CVPRFM	<b>Pot Rack; Floor Standing;</b> S/Steel; 1200 x 600 x 1450; Frame 304 S/S; Mobile



<b>Wall Mounted; Tubular; M/Steel; Painted Available in different sizes</b>	
MARPRTGPM	Mild Steel; painted; per meter
<b>Wall Mounted; Tubular; S/Steel; Available in different sizes</b>	
CVPRW10	Wall Mounted Pot Rack; 1000 x 450
CVPRW15	Wall Mounted Pot Rack; 1500 x 450
CVPRW20	Wall Mounted Pot Rack; 2000 x 450
CVPRWGB	Galvanised Wall Brackety
CVPRWSB	Stainless Steel Wall Bracket



## Shelving

<b>4 Tier Chrome Plated</b>	
BCESUC0905	Shelving Chromed-4 Shelf (905 x 455 x 1830mm)
BCESUC1200	Shelving Chromed-4 Shelf (1200 x 455 x 1830mm)
BCESUC1510	Shelving Chromed-4 Shelf (1510X455X1830mm)

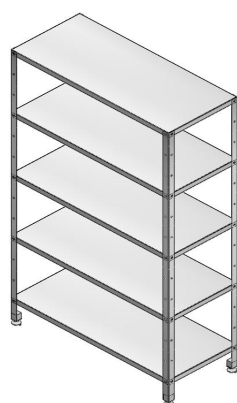

<b>H/Duty Galvanised - Complete Shelves - 5 Tier</b>	
MARSHELVING	Shelves 900mm x 400mm; 0.8mm (Available in 1.0mm)
MARSHELVINGSS	Shelves 850mm x 500mm; 0.8mm (Available in 1.0mm)
<b>H/Duty Galvanised - Components</b>	
CVSFG90	Shelves 900mm x 400mm; 0.8mm (Available in 1.0mm)
CVSFG85	Shelves 850mm x 500mm; 0.8mm (Available in 1.0mm)
CVSFG11	Shelves 1150mm x 500mm; 0.8mm (Available in 1.0mm)
CVSGP16	Posts - 1650; 1.6mm (Available in 2.0mm)
CVSGP19	Posts - 1950 1.6mm (Available in 2.0mm)
CVSGPA16	Posts; adjustable feet - 1650; 2.0mm
CVSGPA19	Posts; adjustable feet - 1950; 2.0mm
<b>H/Duty Stainless Steel - Components</b>	
CVSFS90	Shelves 900mm x 400mm; 430 S/S; 0.9mm; (available in higher grades)
CVSFS85	Shelves 850mm x 500mm; 430 S/S; 0.9mm; (available in higher grades)
CVSFS11	Shelves 1150mm x 500mm; 430 S/S; 0.9mm; (available in higher grades)
CVSSP16	Posts - 1650; 430 S/S; 2.0mm; (Available in 304 S/S)
CVSSP19	Posts - 1950; 430 S/S; 2.0mm; (Available in 304 S/S)
CVSSPA16	Posts; adjustable feet - 1650; 430 S/S; 2.0mm; (Available in 304 S/S)
CVSSPA19	Posts; adjustable feet - 1950; 430 S/S; 2.0mm; (Available in 304 S/S)

# Industrial Kitchen Equipment Catalogue



Order Code	Description
<b>Polypropylene Shelving</b>	
H/Duty Load Up to 1 Ton; Rustproof; Interlocking; dishwasher safe; Easy to clean; Adjustable levelling	

## 4 Tier Polypropylene Shelving

BCESUP0910	4 Tier; <i>Polypropylene Shelving</i> ; 910 x 610 x 1800 H
BCESUP1221	4 Tier; <i>Polypropylene Shelving</i> ; 1220 x 530 x 1800 H
BCESUP1223	4 Tier; <i>Polypropylene Shelving</i> ; 1220 x 610 x 1800 H
BCESUP1525	4 Tier; <i>Polypropylene Shelving</i> ; 1525 x 610 x 1800 H
BCESUP1910	4 Tier; <i>Polypropylene Shelving</i> ; 910 x 530 x 1800 H
BCESUP2525	4 Tier; <i>Polypropylene Shelving</i> ; 1525 x 530 x 1800 H



## 4 Tier Polypropylene Corner Units

BCESUP5220	<i>Polypropylene Corner Unit</i> ; 1220 x 530 x 1800 H
BCESUP5525	<i>Polypropylene Corner Unit</i> ; 1525 x 530 x 1800 H
BCESUP5910	<i>Polypropylene Corner Unit</i> ; 910 x 530 x 1800 H
BCESUP6220	<i>Polypropylene Corner Unit</i> ; 1220 x 610 x 1800 H
BCESUP6525	<i>Polypropylene Corner Unit</i> ; 1525 x 610 x 1800 H
BCESUP6910	<i>Polypropylene Corner Unit</i> ; 910 x 610 x 1800 H



## Spare Polypropylene Shelves

BCESUP8220	<i>Polypropylene Spare Shelf</i> ; 1220 x 610
BCESUP8525	<i>Polypropylene Spare Shelf</i> ; 1525 x 610
BCESUP8910	<i>Polypropylene Spare Shelf</i> ; 910 x 610
BCESUP9220	<i>Polypropylene Spare Shelf</i> ; 1220 x 530
BCESUP9525	<i>Polypropylene Spare Shelf</i> ; 1525 x 530
BCESUP9910	<i>Polypropylene Spare Shelf</i> ; 910 x 530

## Wall Mounted Shelves; (available in different sizes)

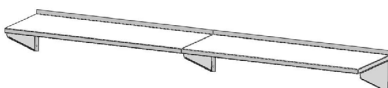

### Galvanised

CVSWG10	Wall Shelf; Galvanised; 1.0mm; 1000 x 400
CVSWG15	Wall Shelf; Galvanised; 1.0mm; 1500 x 400
CVSWG20	Wall Shelf; Galvanised; 1.0mm; 2000 x 400

### S/Steel; (Available in higher S/Steel Grades and thicknesses)

CVSWS10	Wall Shelf; S/Steel; 430 S/S; 0.9mm; 1000 x 400
CVSWS15	Wall Shelf; S/Steel; 430 S/S; 0.9mm; 1500 x 400
CVSWS20	Wall Shelf; S/Steel; 430 S/S; 0.9mm; 2000 x 400

CVSWG B	Galvanised Wall Brackety
CVSWS B	Stainless Steel Wall Bracket

### Microwave & Salamander Shelves

MARMWS55	Microwave Shelf; 550 x 450
MARSAS64	Salamander Shelf; 640 x 450



# Industrial Kitchen Equipment Catalogue

Order Code	Description
<b>Tables - Stainless Steel</b>	
Different sizes can be made. The more common sizes are listed below; (Available in S/Steel 430; 0.9mm; Ava 430 1.2mm; and 304 S/S 0.9 and 1.2mm)	

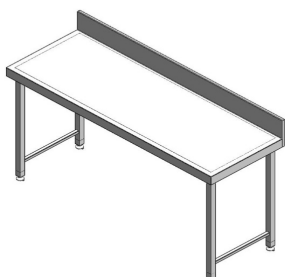

<b>Stainless Steel Table Top w Galvanised legs; <u>with</u> Splash Back - Value Range</b>	
MARGT11	S/Steel Top w Galvanised Legs; 1100w x 680d x 900h
MARGT17	S/Steel Top w Galvanised Legs; 1700w x 680d x 900h
MARGT23	S/Steel Top w Galvanised Legs; 2300w x 680d x 900h

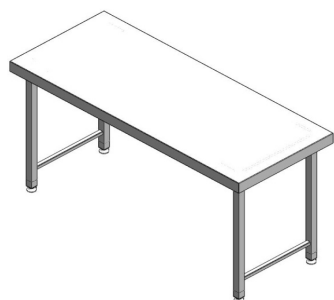

<b>Stainless Steel Table &amp; Legs; <u>No</u> Splash Back</b>	
CVST9480	Table; 430 S/S; 0.9mm; 800w x 750d x 900h
CVST9480S	Table; 430 S/S; 0.9mm; 800; with S/S flat shelf
CVST9410	Table; 430 S/S; 0.9mm; 1000w x 750d x 900h
CVST9410S	Table; 430 S/S; 0.9mm; 1000; with S/S flat shelf
CVST9412	Table; 430 S/S; 0.9mm; 1200w x 750d x 900h
CVST9412S	Table; 430 S/S; 0.9mm; 1200; with S/S flat shelf
CVST9416	Table; 430 S/S; 0.9mm; 1600w x 750d x 900h
CVST9416S	Table; 430 S/S; 0.9mm; 1600; with S/S flat shelf
CVST9418	Table; 430 S/S; 0.9mm; 1800w x 750d x 900h
CVST9418S	Table; 430 S/S; 0.9mm; 1800; with S/S flat shelf
CVST9420	Table; 430 S/S; 0.9mm; 2000w x 750d x 900h
CVST9420S	Table; 430 S/S; 0.9mm; 2000; with S/S flat shelf
CVST9422	Table; 430 S/S; 0.9mm; 2200w x 750d x 900h
CVST9422S	Table; 430 S/S; 0.9mm; 2200; with S/S flat shelf

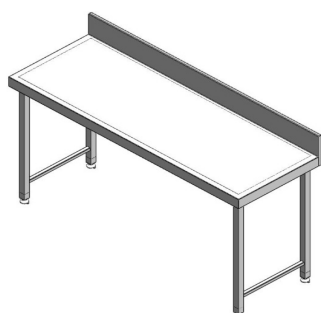

<b>Stainless Steel Table; <u>with</u> Splash Back</b>	
CVSTS80	Table; 430 S/S; 0.9mm; 800w x 750d x 900h
CVSTS80S	Table; 430 S/S; 0.9mm; 800; with S/S flat shelf
CVSTS10	Table; 430 S/S; 0.9mm; 1000w x 750d x 900h
CVSTS10S	Table; 430 S/S; 0.9mm; 1000; with S/S flat shelf
CVSTS12	Table; 430 S/S; 0.9mm; 1200w x 750d x 900h
CVSTS12S	Table; 430 S/S; 0.9mm; 1200; with S/S flat shelf
CVSTS16	Table; 430 S/S; 0.9mm; 1600w x 750d x 900h
CVSTS16S	Table; 430 S/S; 0.9mm; 1600; with S/S flat shelf
CVSTS18	Table; 430 S/S; 0.9mm; 1800w x 750d x 900h
CVSTS18S	Table; 430 S/S; 0.9mm; 1800; with S/S flat shelf
CVSTS20	Table; 430 S/S; 0.9mm; 2000w x 750d x 900h
CVSTS20S	Table; 430 S/S; 0.9mm; 2000; with S/S flat shelf
CVSTS22	Table; 430 S/S; 0.9mm; 2200w x 750d x 900h
CVSTS22S	Table; 430 S/S; 0.9mm; 2200; with S/S flat shelf

# Industrial Kitchen Equipment Catalogue

Order Code	Description
------------	-------------



<b>Mobile Working Table</b>	
BCEWTT0006	Mobile Working Table; 6 Tier; S/Steel; 595 x 670 x 1025mm



<b>Tea Trolleys</b>	
BCETTS0002	Tea Trolleys 2 Tier
BCETTS0003	Tea Trolleys 3 Tier
BCETTS0005	Tea Trolleys 5 Tier



<b>Tray &amp; Cutlery Trolleys</b>	
CVTCT	Tray and Cutlery Trolley 1090 x 530 x 970 H With 2 Cutlery Trays

# Industrial Kitchen Equipment Catalogue

Order Code	Description
------------	-------------



## Extraction Systems

**CANOPY SYSTEMS;** Please contact ISA Hospitality for Extraction system enquiries. These systems are designed and manufactured according to each environment's needs and specifications.

## Point of Sales Counters



**1600 - Blue**

GLCHE1600 | Blue



**1800 - Green**

GLCHE1800 | Green





**umoya**  
unlimited

## Contact us:

Email: [contactus@umoyaunlimited.com](mailto:contactus@umoyaunlimited.com)

Telephone: +27 11 207 6260

Office Hours: 08h30–16h30 (Mon – Fri)

Website: [www.umoyaunlimited.com](http://www.umoyaunlimited.com)

Address: **Unit 18 Gallagher Place**

**Cnr Suttie and Richards Drive**

**Midrand, Gauteng, 1682**

**South Africa**

*For a quote, please contact [contactus@umoyaunlimited.com](mailto:contactus@umoyaunlimited.com)*

